



2014 International Buyer's Guide

EMS FIRE RESCUE EMERGENCY RESPONSE MORTUARY



Equipos de Seguridad Industrial e Institucional, S.A. de C.V.

**ACCESO NORTE 280 INT. 3 SAN LUIS POTOSI, S.L.P. C.P.
78038**

TEL. (444) 5359760 y 8-31-45-09

Correo Electrónico: ventas@esiiaslp.com

ventasesiiaslp2@Gmail.com



Our Vision

Seeking innovation that drives our passion for superior emergency services.

Our Mission

Everyday, Ferno cares and listens to create a safer world for you.

Our Purpose

Seeking to be trusted advisors, by listening to understand your needs, inspires us to create and deliver valued solutions in premier EMS, Rescue, Fire, Police, and Mortuary services.



TABLE OF CONTENTS

| | |
|--|----------------|
| PATIENT HANDLING | 4-53 |
| Transporters, Cots & Trolleys | 4-33 |
| Stair Chairs & Carry Chairs | 34-39 |
| Accessories & Defibrillator Mounts | 40-45 |
| Cot Fasteners | 46-47 |
| Stretchers | 48-53 |
| BARIATRICS | 54-57 |
| Cots, Trolleys & Chairs | 54-55 |
| Bariatric Boards & Accessories | 56-57 |
| IMMOBILIZATION | 58-69 |
| Backboards | 58-61 |
| Scoop Stretchers | 62-64 |
| Restraints | 65 |
| Head Immobilizers & Cervical Collars | 66-67 |
| Extrication Devices | 68-69 |
| SPLINTING | 70-75 |
| Traction Splints | 70 |
| Splints | 71, 75 |
| Vacuum Mattresses & Vacuum Splints | 72-74 |
| PEDIATRICS | 76-79 |
| Pediatric Transport & Immobilization | 76-77 |
| Incubator Transporters | 78-79 |
| BAGS & CASES | 80-87 |
| Ferno Bags | 80-84 |
| Saver Bags | 85 |
| Hard Cases | 86-87 |
| AIRWAY & OXYGEN | 88-97 |
| Regulators | 88-89 |
| Administrators, Masks, Valves, BVMs & Hoses | 90-92 |
| Oxygen Bottles & Holders | 93-94 |
| Airway Kits | 95 |
| Intubation & Accessories | 96-97 |
| RESCUE | 98-111 |
| Basket Stretchers, Litters & Rescue Stretchers | 98-105 |
| Belays, Bridles, Rope Accessories & Harnesses | 106-109 |
| Backpacks | 110 |
| RDC & Sea Scoopa | 111 |
| SAVER | 112-115 |
| Cots, Stair Chairs & Stretchers | 112-114 |
| Immobilization | 115 |
| MORTUARY | 116-121 |
| Cots & Stretchers | 116-117 |
| Scoop, Disaster Pouch & Side Extension Panels | 118 |
| Operating Tables | 119 |
| Church Trucks | 120 |
| Mortuary Fridges | 121 |



Mondial® Transporter

The Mondial® has been designed with Ferno's Smart-Load™ system technology to make your job easier with smooth, simple, ergonomic operation of the transporter when loading and unloading from an ambulance, and when lifting or lowering the patient load at the scene.

- ↳ Reduce wrist strain and set body position before lifting or lowering the patient with the EZ Pull™ Release Handle
- ↳ Positive visual feedback when the legs are locked or unlocked using the leg lock indicator
- ↳ Provide additional safety on uneven surfaces with control-end wheel locks
- ↳ Loading-end swivel wheel locks
- ↳ Conforms to International Standards EN1865, EN1789



- 1 **Smart-Load™ Auto-Release System**, featuring the loading-end leg automatic release mechanism and optional control-end leg automatic release mechanism, provides smooth, safe and easy loading and unloading.
- 2 **All-Metal Frame Construction** provides strength, long service life, and exceptional performance with patients up to 270 kg.
- 3 **Swivel-Lock Release Mechanism** provides maximum maneuverability in tight spaces.
- 4 **Large 150 mm Soft-Ride Wheels** with two wheel locks provide easy rolling over all terrains. In the Option 1 and 2 packages, two wheels are conductive with an antistatic feature.



4



5

Color-Coded Controls and Automatic Leg Release provides easy, intuitive operation.



6

Reflective Labeling provides nighttime visibility for added safety.



7

Multiple Height Positions provide easy patient transfer from different surface levels.

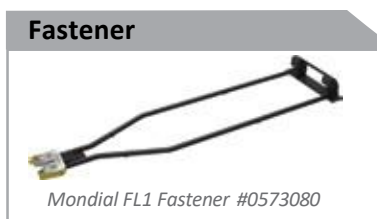

| | BASE PKG | | OPTION 1 | | OPTION 2 | |
|--------|----------|---------|----------|---------|----------|---------|
| | ST64 | ST70 | ST64 | ST70 | ST64 | ST70 |
| Red | 0054222 | 0054219 | 0054229 | 0054231 | 0054238 | 0054241 |
| Silver | 0054227 | 0054228 | 0054230 | 0054232 | 0054239 | 0054242 |
| Green | 0054223 | 0054220 | 0054236 | 0054235 | 0054240 | 0054243 |

Base Pkg includes Auto Loading-End Leg Release
Option 1 includes Base Pkg features plus Leg Lock, the SmartLoad™ Control-End Leg Auto Release System and Conductive Wheels
Option 2 includes Base Pkg features plus Leg Lock, the SmartLoad™ Loading-End Leg Auto Release System, Conductive Wheels, Safety Lock Device and Tracker Bracket



SPECIFICATIONS

| | Length | Width | Height Max | Height Min | Folded Height | Loading Height | Weight | Load Limit | Shipping Weight | Shipping L,W,H |
|----------------------|--------|---------|------------|------------|---------------|----------------|--------|------------|-----------------|-----------------|
| ST64 Imperial 78 in. | 22 in. | 39 in. | 14 in. | 14 in. | 14 in. | 27-29 in. | 62 lb | 600 lb | 80 lb | 83x27x14 in. |
| ST64 Metric 1970 mm | 550 mm | 987 mm | 356 mm | 346 mm | 346 mm | 670-730 mm | 28 kg | 270 kg | 36 kg | 2108x686x356 mm |
| ST70 Imperial 78 in. | 22 in. | 41 in. | 14 in. | 14 in. | 14 in. | 29-31 in. | 62 lb | 600 lb | 80 lb | 83x27x14 in. |
| ST70 Metric 1970 mm | 550 mm | 1045 mm | 352 mm | 343 mm | 343 mm | 700-790 mm | 28 kg | 270 kg | 36 kg | 2108x686x356 mm |

Mondial® RS2 Lift-Off Stretcher

- Ì Anodized tubing prevents oxidation for clean hands and clothing
- Ì Features shock position and contour position
- Ì Swing-down sidearms
- Ì Infinitely-adjustable gas-assist backrest, adjusts up to 80°
- Ì Four wheels (100 mm / 4 in.)
- Ì Two telescoping side lift handles
- Ì Two Model 430 restraints and one 417-EFX restraint included
- Ì Reversible patient loading: head first or feet first
- Ì Compatible with the Mondial® Transporter
- Ì Stationary footrest included as standard
- Ì Choice of external or internal bolster mattress (sold separately)



- Mondial® RS2.1 with Standard Backrest & Storage Tray #0153232
- Mondial® RS2.2 with Extending Backrest & Storage Tray #0153233
- Mondial® RS2.3 with Airway Management & Storage Tray #0153234
- Mondial® RS2.1 without Storage Tray #0153240
- DIN Pin Kit Accessory #0832167

Mondial® RS3 Lift-Off Stretcher

- Ì Anodized tubing prevents oxidation for clean hands and clothing
- Ì Features shock position and contour position
- Ì Swing-down sidearms
- Ì Infinitely-adjustable gas-assist backrest, adjusts up to 80°
- Ì Four wheels (100 mm / 4 in.)
- Ì Two telescoping side lift handles
- Ì Two Model 430 restraints and one 417-EFX restraint included
- Ì Compatible with the Mondial® Transporter
- Ì Reversible patient loading: head first or feet first
- Ì Pivoting footrest is standard
- Ì Built-in mounting rings for lifting harness
- Ì Features U-frame
- Ì Choice of external or internal bolster mattress (sold separately)



- Mondial® RS3.1 with Standard Backrest & Storage Tray #0153235
- Mondial® RS3.2 with Extending Backrest & Storage Tray #0153236
- Mondial® RS3.1 without Storage Tray #0153241
- DIN Pin Kit Accessory #0832167

Accessories



417 Restraints
#0313996



430 Restraints
#0313892 (2pc. 5' blk)
#0313910 (1pc. 7' blk)



Mondial RS IV Pole
#0090016



514 Oxy-Clip
#0085500



Mattress
Externally Bolstered
#0374874



Mattress
Internally Bolstered
#0374875

SPECIFICATIONS

| | Length | Width | Height | Weight | Load Limit | Shipping Weight | Shipping L,W,H |
|--------------|---------|--------|--------|---------|------------|-----------------|----------------|
| RS2 Imperial | 77 in. | 22 in. | 6 in. | 50.4 lb | 500 lb | 80lb | 83x27x14in. |
| RS2 Metric | 1950 mm | 550 mm | 150 mm | 22.9 kg | 230 kg | 36kg | 2108x686x356mm |
| RS3 Imperial | 77 in. | 22 in. | 6 in. | 49.8 lb | 500 lb | 80lb | 83x27x14in. |
| RS3 Metric | 1950 mm | 550 mm | 150 mm | 22.6 kg | 230 kg | 36kg | 2108x686x356mm |



Mondial® RS4 Lift-Off Stretcher

- Ì Anodized tubing prevents oxidation for clean hands and clothing
- Ì Infinitely-adjustable gas-assist backrest, adjusts up to 80°
- Ì Four wheels (100 mm / 4 in.)
- Ì Two telescoping side lift handles
- Ì Two Model 430 restraints and one 417-EFX restraint included
- Ì Compatible with the Mondial® Transporter
- Ì Reversible patient loading: head first or feet first
- Ì Pivoting footrest is standard
- Ì Built-in mounting rings for lifting harness
- Ì Features U-frame
- Ì Choice of external or internal bolster mattress (sold separately)



- Mondial® RS4.2#0153237
DIN Pin Kit Accessory#0832167

Ferno® Lift-Off Stretcher Chair

- Ì Anodized tubing prevents oxidation for clean hands and clothing
- Ì Features shock position and contour position
- Ì Swing-down side arms
- Ì Infinitely-adjustable gas-assist backrest
- Ì Four wheels (100 mm / 4 in.)
- Ì Two telescoping side lift handles
- Ì Two Model 430 restraints and one 417-EFX restraint included
- Ì Compatible with the EFX Transporter and Mondial® Transporter with use of Conversion Kit (#0832175)
- Ì Reversible patient loading: head first or feet first
- Ì Converts to chair or stretcher
- Ì Mattress, 2-piece, 50 mm / 2 in. thick (sold separately)



- Stretcher with Headrest Option#0153178
Stretcher with Footrest Option#0153179
Stretcher with Footrest and Headrest Option#0153181
Stretcher with Foot Sack Option#0153185
EFX Conversion Kit for Mondial#0832175



Mattress Set
#0374855



x4 each
EFX Conversion Kit
for Mondial -#0832175



Accessories



417 Restraints
#0313996

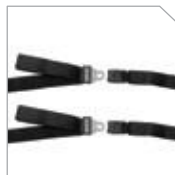

430 Restraints
#0313892 (2pc. 5' blk)
#0313910 (1pc. 7' blk)



Mondial RS IV Pole
#0090016



514 Oxy-Clip
#0085500



For RS4 Stretcher
Mattress
Externally Bolstered
#0374874



For RS4 Stretcher
Mattress
Internally Bolstered
#0374875

SPECIFICATIONS

| | Length Max. | Length Min. | Width | Overall Height | Bed Height | Chair Height | Seat Height | Chair Depth | Seat Depth | Weight | Load Limit | Shipping Weight | Shipping L,W,H |
|----------------|-------------|-------------|--------|----------------|------------|--------------|-------------|-------------|------------|---------|------------|-----------------|-----------------|
| RS4 Imperial | 77 in. | 77 in. | 22 in. | 6 in. | | | | | | 46.4 lb | 500 lb | 80 lb | 83x27x14 in. |
| RS4 Metric | 1950 mm | 1950 mm | 550 mm | 150 mm | | | | | | 21 kg | 230 kg | 36 kg | 2108x686x356 mm |
| Chair Imperial | 91 in. | 76 in. | 22 in. | 13 in. | 5.5 in. | 55 in. | 20 in. | 29 in. | 17 in. | 51 lb | 500 lb | 90 lb | 84x27x20 in. |
| Chair Metric | 2300 mm | 1940 mm | 560 mm | 340 mm | 140 mm | 1400 mm | 510 mm | 740 mm | 430 mm | 23 kg | 230 kg | 41 kg | 2108x686x508 mm |





Mondial® Monobloc

The Mondial® Monobloc has been designed with Ferno's Smart-Load™ system technology to make your job easier with smooth, simple, ergonomic operation of the cot when loading and unloading from an ambulance, and when lifting or lowering the patient load at the scene.

- ↳ Reduce wrist strain and set body position before lifting or lowering the patient with the EZ Pull™ Release Handle
- ↳ Positive visual feedback when the legs are locked or unlocked using the leg lock indicator
- ↳ Easy patient transfer from different surface levels using multiple height positions
- ↳ Provide additional safety on uneven surfaces with control-end wheel locks
- ↳ Nighttime visibility on-scene with reflective labels
- ↳ Conforms to International Standards EN1865, EN1789



- 1 Smart-Load™ Auto-Release System**, featuring the loading-end leg automatic release mechanism and optional control-end leg automatic release mechanism, provides smooth, safe and easy loading and unloading.
- 2 All-Metal Frame Construction** provides strength, long service life, and exceptional performance with patients up to 280 kg.
- 3 Swivel-Lock Release Mechanism** provides maximum maneuverability in tight spaces.
- 4 Large 150 mm Soft-Ride Wheels** with two wheel locks provide easy rolling over all terrains. In the Option 1 and 2 packages, two wheels are conductive with an antistatic feature.



5 Side Lift Handles allow additional operators to provide added lift assistance on heavy patient loads.



6 Telescoping Handles support optimal ergonomics for operators when lifting or moving the cot.



8 Color-Coded Controls and Automatic Leg Release provides easy, intuitive operation.



7 Extending Headrest to accommodate taller patients or an Airway Management Headrest that tilts down for optimal airway position for intubation (optional).

| | BASE PKG | | OPTION 1 | | OPTION 2 | | OPTION 3 | |
|---------------|----------|---------|----------|---------|----------|---------|----------|---------|
| | MB64 | MB70 | MB64 | MB70 | MB64 | MB70 | MB64 | MB70 |
| Red | 0054246 | 0054249 | 0054252 | 0054255 | 0054258 | 0054261 | 0054264 | 0054267 |
| Silver | 0054247 | 0054250 | 0054253 | 0054256 | 0054259 | 0054262 | 0054265 | 0054268 |
| Green | 0054248 | 0054251 | 0054254 | 0054257 | 0054260 | 0054263 | 0054266 | 0054269 |

Base Pkg includes Reclining Backrest, Restraints, Shock/Contour Foot Panel, Sidearms, Scuff Strip Rollers, Footrest, Auto Loading-end Leg Release
Option 1 includes Base Pkg features plus Telescoping Handles, Leg Lock, Smart-Load™ Control-end Leg Auto Release System, Conductive Wheels, Extending Headrest, Side Lift Handles, Storage Tray
Option 2 includes all Option 1 features plus Safety Lock Device and Tracker™
Option 3 includes all Option 1 & 2 features except it has an Airway Management Headrest

Accessories & Fastener



Torso Restraints
#1204016

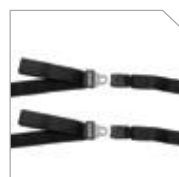

430 Restraints
#0313892 (2pc. 5' blk)
#0313910 (1pc. 7' blk)



Mondial MB IV Pole
#0832197



PacRac™+
#FWEPR



Mattress Externally Bolstered
#0374874



Mattress Internally Bolstered
#0374875



FL1 Fastener
#0573080

SPECIFICATIONS



| | Length | Width | Height Max | Height Min | Folded Height | Loading Height | Weight | Load Limit | Shipping Weight | Shipping L,W,H |
|-------------|---------|--------|------------|------------|---------------|----------------|----------|------------|-----------------|-----------------|
| MB64 Imper. | 78 in. | 22 in. | 37 in. | 13 in. | 12 in. | 27-29 in. | 98 lb | 620 lb | 80 lb | 83x27x14 in. |
| MB64 Metric | 1970 mm | 553 mm | 950 mm | 330 mm | 310 mm | 670-730 mm | 44.45 kg | 280 kg | 36 kg | 2108x686x356 mm |
| MB70 Imper. | 78 in. | 22 in. | 40 in. | 12 in. | 13 in. | 29-31 in. | 98 lb | 620 lb | 80 lb | 83x27x14 in. |
| MB70 Metric | 1970 mm | 553 mm | 1010 mm | 314 mm | 327 mm | 730-790 mm | 44.45 kg | 280 kg | 36 kg | 2108x686x356 mm |





Model 19, York 4 Cot

- Ì Lightweight tubular aluminum construction
- Ì Swing-down sidearms
- Ì Four 127 mm (5 in.) 360° swivel wheels
- Ì Adjustable backrest angles from 0° to 75°
- Ì Adjustable-length lead handle at both ends
- Ì Four telescoping carrying handles
- Ì Can be elevated to contour and Trendelenburg shock positions
- Ì Six height positions
- Ì Compatible with Model 1 Fastener #0561002 (rail only)
- Ì Fastener Wall Mount #0561010
- Ì Fastener Floor Mount #0561020

Model 19 York 4 Cot Only#0052200

Accessories



360 Mattress
#0313692 (burgundy)
#0313691 (orange)



460 Mattress
#0313063 (burgundy)
#0312720 (orange)



513-10IV Pole HD,
Non-Magnetic
#0087156



417-1 Restraints
#0313915 (black)
#0313914 (orange)



430 Restraints
#0313892 (black 5')
#0313891 (orange 5')



514 Oxy-Clip
#0085500

SPECIFICATIONS

| | Length | Width | Height Max. | Height Min. | Weight | Load Limit Cot Use | Load Limit Bench Use | Shipping Weight | Shipping L,W,H |
|----------|---------|--------|----------------|----------------|--------|-----------------------|-------------------------|--------------------|-------------------|
| Imperial | 75 in. | 22 in. | 38 in. | 16 in. | 70 lb | 400 lb | 800 lb | 83 lb | 80x25x13 in. |
| Metric | 1900 mm | 560 mm | 953 mm | 406 mm | 32 kg | 181 kg | 362 kg | 38 kg | 2030x640x330 mm |





Model 25 Cot

The Ferno® Model 25 ambulance cot is simple to operate, with legs that fold as the cot is loaded into the ambulance and unfold as the cot is removed.

- ↳ Simple to use roll-in cot with two levels of height adjustment: fully elevated or ground level
- ↳ Independent folding legs
- ↳ Lightweight tubular aluminum construction provides durability and strength
- ↳ Swing-down sidearms enable convenient patient transfer from bed to cot
- ↳ Two stationary and two 360° swivel wheels
- ↳ Adjustable backrest angles from 0° to 75°
- ↳ Now includes two roll-out wheels at operator end

- Model 25 Cot Only (610 mm Load Height) #0054082
- Model 25 Cot Only (640 mm Load Height) #0054210
- Model 25 Cot Only (530 mm Load Height) #0054211
- Model 25, Restraints, Orange 460 Mattress #0000381
- Model 25, Restraints, Burgundy 460 Mattress #0000445
- Model 25, Restraints, Orange 360 Mattress #0000444

Accessories



360 Mattress

460 Mattress

513 IV Pole

#0313692 (burgundy)
#0313691 (orange)

#0313063 (burgundy)
#0312720 (orange)

#0085130

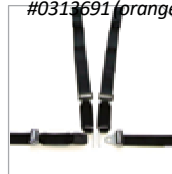

417-1 Restraints

430 Restraints

514 Oxy-Clip

#0313915 (black)
#0313914 (orange)

#0313892 (black 5')
#0313891 (orange 5')

#0085500

Fasteners

Compatible with Model 5-14 and Model 175 Fasteners.
Please refer to pages 46 & 47.

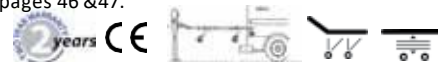

SPECIFICATIONS

| | Length | Width | Folded Bed Height | Loading Height | Weight | Load Limit | Shipping Weight | Shipping L,W,H |
|----------|---------|--------|----------------------|-------------------|--------|---------------|--------------------|-------------------|
| Imperial | 76 in. | 22 in. | 9.5 in. | 24 in. | 49 lb | 400 lb | 68 lb | 80x24x12 in. |
| Metric | 1920 mm | 550 mm | 240 mm | 610 mm | 22 kg | 181 kg | 31 kg | 2032x610x305mm |



Model 26 Cot

- Ì Simple to use roll-in cot with two levels of height adjustment: fully elevated or ground level
- Ì Independent folding legs
- Ì Fold-down drop frame shortens the length of the cot
- Ì Lightweight tubular aluminum construction
- Ì Swing-down sidearms
- Ì Two stationary and two 360° swivel wheels
- Ì Adjustable backrest angles from 0° to 75°
- Ì Includes footrest, leg lock, and safety lock
- Ì Available with bolster mattress, restraints, and shoulder harness for patient comfort and safety
- Ì Now includes two roll-out wheels at the operator end

- Model 26 Cot Only#0012600
- Model 26 Cot Kit, Restraints, Orange 460 Mattress#0000360
- Model 26 Cot Kit, Restraints, Burgundy 460 Mattress#0000388

Accessories



360 Mattress

#0313692 (burgundy)
#0313691 (orange)



460 Mattress

#0313063 (burgundy)
#0312720 (orange)



513 IV Pole

#0085130

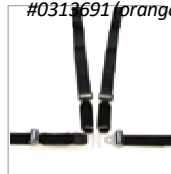

417-1 Restraints

#0313915 (black)
#0313914 (orange)



430 Restraints

#0313892 (black 5')
#0313891 (orange 5')



514 Oxy-Clip

#0085500

Fasteners

Compatible with Model 175 and SLAM-26+ Fasteners.
Please refer to pages 46 & 47.

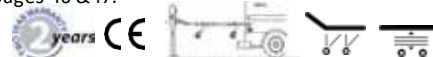

SPECIFICATIONS

| | Overall | Height | Height | Loading | Load | Shipping | Shipping | |
|----------|---------|--------|--------|---------|--------|----------|----------|----------------|
| | Length | Width | Max. | Min. | Height | Weight | Weight | |
| Imperial | 77 in. | 23 in. | 32 in. | 9 in. | 24 in. | 56 lb | 85 lb | 80x25x13 in. |
| Metric | 1950 mm | 580 mm | 810 mm | 220 mm | 610 mm | 25.4 kg | 39 kg | 2032x635x330mm |



Model 26AS



Model 26S and 26AS Cot

- Ì Roll-in cot with two levels of height adjustment: fully elevated or ground level
- Ì Main frame features shock position
- Ì Two stationary wheels, and two 360° swivel wheels with wheel locks
- Ì Independent folding legs
- Ì Available with bolster mattress, restraints, and shoulder harness for patient comfort and safety
- Ì Lightweight tubular aluminum construction
- Ì Swing-down sidearms
- Ì Adjustable backrest angles from 0° to 75°
- Ì Includes footrest, leg lock, and safety lock
- Ì Now includes two roll-out wheels at the operator end
- Ì Fold-down drop frame

- Model 26S Cot Only (shock frame, 2 wheel locks).....#0053976
- Model 26AS Cot Only (additional loading wheels, slam latch)#0054163
- Model 26S Cot Kit, Restraints, Burgundy 460 Mattress.....#000026S
- Model 26S Cot Kit, Restraints, Orange 460 Mattress.....#000026S0460

Accessories



360 Mattress

#0313692 (burgundy)
#0313691 (orange)



460 Mattress

#0313063 (burgundy)
#0312720 (orange)



513 IV Pole

#0085130

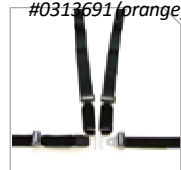

417-1 Restraints

#0313915 (black)
#0313914 (orange)

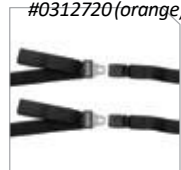

430 Restraints

#0313892 (black 5')
#0313891 (orange 5')



514 Oxy-Clip

#0085500

Fasteners

Compatible with Model 5-14 and Model 175 Fasteners.
Please refer to page 46 & 47.

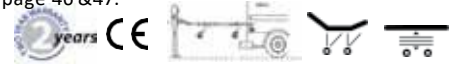

SPECIFICATIONS

| | Length | Overall Width | Height Max. | Height Min. | Loading Height | Weight | Load Limit | Shipping Weight | Shipping L,W,H |
|----------|---------|---------------|-------------|-------------|----------------|--------|------------|-----------------|-----------------|
| Imperial | 77 in. | 23 in. | 32 in. | 9 in. | 24 in. | 56 lb | 400 lb | 68 lb | 80x24x12 in. |
| Metric | 1950 mm | 580 mm | 810 mm | 220 mm | 600 mm | 25 kg | 181 kg | 31 kg | 2032x610x305 mm |



Model 28 Ferno-Flex™ Roll-In Chair Cot

The heavy-duty Model 28 Ferno-Flex™ Roll-In Chair Cot quickly converts to any of five positions for easy maneuvering in narrow hallways, elevators, and other confined spaces.

- ↳ Legs automatically lock in place when unloading cot
- ↳ Rectangular tubular aluminum construction
- ↳ Lubrication-free rotating components for easy movements
- ↳ Swing-down sidearms
- ↳ Two 127 mm (5 in.) stationary and two 127 mm (5 in.) swivel wheels
- ↳ Loading wheels provide easier loading and unloading
- ↳ Leg lock clip
- ↳ Black restraints and mattress available in orange or burgundy



- 1 Versatile Patient Transport** with easy transition from cot to chair provides maneuverability and flexibility in challenging structural environments without the need to transfer patients to other carrying devices.
- 2 Unparalleled Maneuverability** with 1140 mm length in chair position provides the shortest length of any cot in the market for working in confining areas such as tight hallways, small elevators, and narrow staircases.
- 3 Lightest-Weight** roll-in style chair cot on the market at 30kg (67 lb), making it easier to operate.
- 4 All-Metal Frame Construction** provides strength, long service life, and exceptional performance with heavy patients.



5 Single Release mechanism changes cot into one of five locked positions.



4 All-Metal Frame Construction provides strength and long service life.



1 Versatile Patient Transport with easy transition from cot to chair.



6 Adjustable Backrest with eight positions from angles 0° to 75°.

- Model 28, Cot Only..... #0012801
- Model 28 Kit, Restraints, Burgundy Mattress #0000401
- Model 28 Kit, Restraints, Orange Mattress..... #0000402

Accessories & Fastener

| | | | | | | |
|--|---|---|---|--------------------------|---------------------------|--|
| | | | | | | |
| 359-8 Mattress #0313099 (burgundy) #0311220 (orange) | 417-1 Restraints #0313915 (black) #0313914 (orange) | 430 Restraints #0313892 (black 5') #0313891 (orange 5') | 513-11, IV Pole HD, Non-Magnetic #0087157 | 514 Oxy-Clip #0085520 | 274-S PacRac™ #0818952 | 173-2 Fastener #0001732F 173-3 Fastener #0001733F |

SPECIFICATIONS

| | Chair | Bed Height | Bed Height | Load | Overall | Length | Length | Weight | Load | Shipping | Shipping |
|----------|---------|------------|------------|--------|---------|---------|----------|--------|--------|----------|---------------------|
| | Depth | Min | Max | Height | Width | Folded | Unfolded | | Limit | Weight | L,W,H, ² |
| Imperial | 45 in. | 8 in. | 32 in. | 26 in. | 23 in. | 78 in. | 75 in. | 67 lb | 650 lb | 115 lb | 83x26x12 in. |
| Metric | 1140 mm | 200 mm | 810 mm | 650 mm | 580 mm | 1980 mm | 1910 mm | 30 kg | 295 kg | 52 kg | 2108x660x305mm |





Model 35A Cot

- ↳ X-frame undercarriage is easily raised or lowered by second EMT when loading or unloading
- ↳ 8 Bed Positions provide easy patient transfer from different surface levels when loading or unloading
- ↳ Foot-end lead handle, and side release handle
- ↳ Two loading heights
- ↳ One-hand swing-down sidearms
- ↳ Safety U-Bar and Hook to hold cot inside ambulance as undercarriage is raised or lowered
- ↳ Built-in shock frame
- ↳ Black restraints and mattress available in orange or burgundy



- 1** **Fold-Down Drop Frame** allows better maneuverability in confined spaces.
- 2** **Gas-Assist Backrest** adjusts from 0° to 75° for optimal patient comfort.
- 3** **Tubular Aluminum Construction** makes the cot durable yet lightweight to operate.

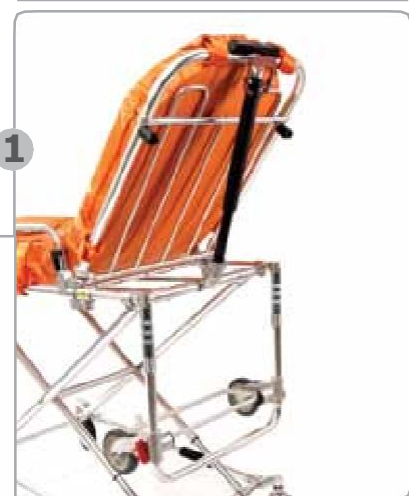

4 **Lubrication-Free, Easy-Roll Wheels** make transport smooth on most surfaces.

Model 35A+ has all the features of the Model 35A, plus

- ↳ Panel bed surface for enhanced patient comfort
- ↳ Larger ergonomic sidearms
- ↳ Lower accessory tray
- ↳ Built-in oxygen cylinder holder

- Model 35A Cot Only #0012079
- Model 35A Kit, Restraints, Orange 460 Mattress #0000406
- Model 35A Kit, Restraints, Burgundy 460 Mattress #0000291
- Model 35A-NM Non-Magnetic Cot with Restraints #0015612
- Model 35A+ Cot Only #0015596
- Model 35A+ Kit, Restraints, Burgundy 460 Mattress #0000305

Accessories & Fastener



360 Mattress
#0313692 (burgundy)
#0313691 (orange)



460 Mattress
#0313063 (burgundy)
#0312720 (orange)



417-1 Restraints
#0313915 (black)
#0313914 (orange)



430 Restraints
#0313892 (black 5')
#0313891 (orange 5')

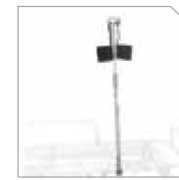

513-10 IV Pole
#0087156



514 Oxy-Clip
#0085500



274-SPacRac™
#0818933

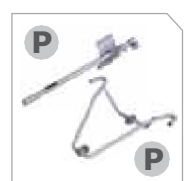

175-1 Fastener
#0001751F

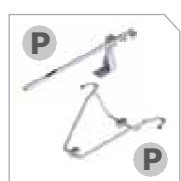

175-2 Fastener
#0001752F



175-3 Fastener
#0001753F

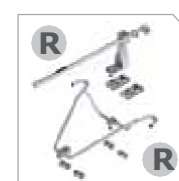

175-4 Fastener
#0001754F

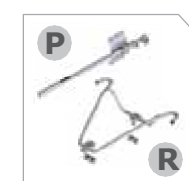

175-5 Fastener
#0001755F

SPECIFICATIONS

| | Length Max | Length Min | Width | Height Max | Height Min | Loading Height 1 | Loading Height 2 | Weight | Load Limit | Shipping Weight | Shipping L,W,H |
|---------------|---------------|---------------|--------|---------------|---------------|---------------------|---------------------|--------|---------------|--------------------|-------------------|
| 35A Imperial | 79 in. | 61 in. | 24 in. | 35 in. | 10 in. | 28 in. | 32 in. | 74 lb | 500 lb | 105 lb | 83x25x18in. |
| 35A Metric | 2007 mm | 1549 mm | 610 mm | 883 mm | 257 mm | 711 mm | 810 mm | 34 kg | 227 kg | 43 kg | 2108x635x457 mm |
| 35A+ Imperial | 79 in. | 63 in. | 24 in. | 35 in. | 10 in. | 28 in. | 32 in. | 84 lb | 500 lb | 120 lb | 83x25x20in. |
| 35A+ Metric | 2007 mm | 1549 mm | 610 mm | 883 mm | 257 mm | 711 mm | 810 mm | 38 kg | 227 kg | 54 kg | 2108x635x508 mm |



Model 93-ES Squadmate[®] Cot

- Ì Sturdy H-frame lightweight aluminum construction
- Ì Control system has two channels for added rigidity
- Ì Swing-down sidearms
- Ì Lubrication-free, easy-roll wheels
- Ì Shockframe
- Ì Eight-position adjustable backrest angles from 0° to 75°
- Ì Five height positions for efficiency and flexibility
- Ì Fold-down drop frame
- Ì Lead handle at foot end
- Ì Four swivel wheels
- Ì Restraints available in orange or black
- Ì Mattress available in burgundy or orange

- Model 93-ES Cot Only.....#0015574
- Model 93-ES, Restraints, Orange 460 Mattress.....#0000307
- Model 93-ES, Restraints, Burgundy 460 Mattress.....#0000370

Fasteners

Compatible with Model 175 Fasteners.
Please refer to pages 46 & 47.

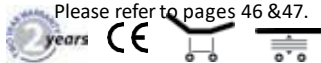

5

Accessories



360 Mattress

#0313692 (burgundy)
#0313691 (orange)



460 Mattress

#0313063 (burgundy)
#0312720 (orange)



513-10 IV Pole

#0087156

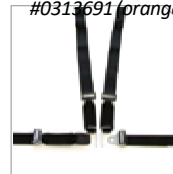

417-1 Restraints

#0313915 (black)
#0313914 (orange)



430 Restraints

#0313892 (black 5')
#0313891 (orange 5')



514 Oxy-Clip

#0085500



274 PacRac™

#0818933

SPECIFICATIONS

| | Length Max | Length Min | Overall Width | Height Max | Height Min | Loading Height | Height Mid-Level | Height Low-Level | Weight | Load Limit | Shipping Weight | Shipping L,W,H |
|----------|---------------|---------------|------------------|---------------|---------------|-------------------|---------------------|---------------------|--------|---------------|--------------------|-------------------|
| Imperial | 81 in. | 66 in. | 23 in. | 32 in. | 9 in. | 30 in. | 23 in. | 19 in. | 77 lb | 500 lb | 115 lb | 85x25x20in. |
| Metric | 2050 mm | 1680 mm | 590 mm | 800 mm | 230 mm | 770 mm | 590 mm | 500 mm | 35 kg | 227 kg | 52 kg | 2159x635x508mm |



5126Cot

Model 5126EL Cot

The 5126EL Cot has been designed with an internal frame stiffener for strength and stability that is unmatched in the industry.

- ↳ Seven levels of height adjustment
- ↳ Ergonomic height adjustment handle provides an improved, comfortable grip
- ↳ EZ-Load™ front leg automatic release mechanism
- ↳ Anodized tubing prevents oxidation for clean hands and clothing
- ↳ Footrest included
- ↳ Swing-down sidearms
- ↳ Shock frame
- ↳ Conforms to International Standards EN 1789 and EN 1865

- Model 5126EL, 64 cm, with EZ Load (from Saver-Cot Only) #0054209
- Model 5226EL, 70 cm, with EZ Load (from Saver-Cot Only) #0054213
- Model 5126 Cot Only, without EZ Load #0054158
- Model 5126 Cot, without EZ Load, Restraints, Orange Matt. #0005126O
- Model 5126 Cot, without EZLoad, Restraints, Burg. Matt..... #0005126M

Accessories & Fastener



5126EL Mattress
#65-0360-001



460 Mattress
#0312720 (orange)



513-10 IV Pole



417-1 Restraints
#0313915 (black)



430 Restraints
#0313892 (black 5')
#0313911 (black 7')

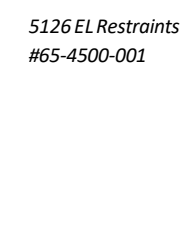

5126 EL Restraints
#65-4500-001



7

514 Oxy-Clip
#0085500

SLAM-5026/EFX
Fastener

SPECIFICATIONS

| | Length | Width | Folded Height | Loading Height | Weight | Load Limit | Shipping Weight | Shipping L,W,H |
|----------|---------|--------|---------------|----------------|--------|------------|-----------------|----------------|
| Imperial | 78 in. | 22 in. | 10 in. | 25 in. | 95 lb | 400 lb | 100 lb | 84x28x20in. |
| Metric | 1970 mm | 550 mm | 250 mm | 640 mm | 43 kg | 181 kg | 45 kg | 2133x711x508mm |





Models 4051/4052 Transporters

The 4051 and 4052 Transporters have been designed with an internal frame stiffener for strength and stability.

- ↳ 7 levels of height adjustment
- ↳ Ergonomic height-adjustment handle provides an improved, comfortable grip
- ↳ Two loading heights (640 mm/25 in. or 700 mm/28 in.)
- ↳ Anodized tubing prevents oxidation for clean hands and clothing
- ↳ Conforms to International Standards EN 1789 and EN 1865

Model 4051 Transporter with 640 mm/25 in. Load Height#0054099

Model 4052 Transporter with 700 mm/28 in. Load Height#0054100



Model 4152 with Model 4141 Lift-Off Stretcher



Fastener

SLAM-4050



SPECIFICATIONS

| | Frame Length | Frame Width | Overall Width | Frame Height | Loading Height | Frame Height | Loading Height | Weight | Load Limit | Ship Weight | Ship Weight | Shipping L, W, H |
|----------|--------------|-------------|---------------|--------------|----------------|--------------|----------------|--------|------------|-------------|-------------|------------------|
| | 4051 | 4051 | 4051 | 4051 | 4051 | 4052 | 4052 | 4051 | 4051 | 4052 | 4052 | |
| Imperial | 78 in. | 17 in. | 22 in. | 33 in. | 25 in. | 35 in. | 28 in. | 55 lb | 400 lb | 68 lb | 69 lb | 81x25x11in. |
| Metric | 1970 mm | 440 mm | 570 mm | 830 mm | 640 mm | 900 mm | 700 mm | 25 kg | 181 kg | 31 kg | 31 kg | 2057x635x279 |

Models 4141 Lift-Off Stretcher

The 4140 Lift-Off Stretcher series is designed to accommodate a wide range of patient needs and emergency situations.

- ↳ Engineered for use with the 4050 Series Transporters
- ↳ Stretcher may be reversed to enable patient to be loaded head or feet first
- ↳ Gas-assist backrest with infinite range of adjustment from 0° to 90° (4141)
- ↳ Four telescoping carrying handles
- ↳ Swing-down sidearms enable smooth patient transfer to and from stretcher
- ↳ Conforms to International Standards EN 1789 and EN 1865
- ↳ Airway management system
- ↳ Includes Model 429 restraint kit
- ↳ Mattress (Model 359-20) not included



Model 4141

Model 4141 Lift-Off Stretcher w/ Airway Management Sys..... #0153145



359-20/22 Mattress
#0372250



429 Restraint Kit
#0819688 (black)



430 Restraints
#0313892 (black 5')



514 Oxy-Clip
#0085500



Model 4153 Lift-Off Stretcher Chair

The 4153 Lift-Off Stretcher Chair is designed to accommodate a wide range of patient needs and emergency situations, including rescue in confined areas.

- ↳ Engineered for use with the 4050 Series Transporters
- ↳ Converts to chair or stretcher
- ↳ Stretcher may be reversed to enable patient to be loaded head- or feet-first
- ↳ Gas-assist, infinitely-adjustable backrest up to 73° angle
- ↳ Flat and contour shock frame
- ↳ Four extending carrying handles
- ↳ Swing-down sidearms enable smooth patient transfer from stretcher to bed
- ↳ Conforms to International Standards EN 1789 and EN 1865
- ↳ Includes Model 429 restraint kit
- ↳ Mattress (Model 359-11) not included



Model 4153 Lift-Off Stretcher Chair..... #0153142



359-11 Mattress
#0371400 (orange)



429 Restraint Kit
#0819688 (black)



430 Restraints
#0313892 (black 5')



513-13 IV Pole
#0087172



514 Oxy-Clip
#0085500



SPECIFICATIONS

| | Length Max. | Length Min. | Width | Stretcher Height | Chair Height | Chair Depth | Weight | Load Limit | Shipping Weight | Shipping L,W,H |
|---------------|-------------|-------------|--------|------------------|--------------|-------------|---------|------------|-----------------|-----------------|
| 4141 Imperial | 93 in. | 74.5 in. | 24 in. | 6.5 in. | | | 47 lb | 400 lb | 67 lb | 8x25x13 in. |
| 4141 Metric | 2369 mm | 1892 mm | 616 mm | 165 mm | | | 21.5 kg | 181 kg | 30 kg | 2030x640x330 mm |
| 4153 Imperial | 94 in. | 78 in. | 22 in. | 6 in. | 59 in. | 22 in. | 44 lb | 400 lb | 53 lb | 80x25x13 in. |
| 4153 Metric | 2380 mm | 1990 mm | 550 mm | 150 mm | 1500 mm | 560 mm | 20 kg | 181 kg | 24 kg | 2030x640x330 mm |



Complete Bariatric Solution with load frame handlebar, 454 kg load capacity in the lowest position, & optional LBS Bariatric Board (see page 54-57 for more bariatric solutions).



POWERFlex® + Powered Cot

The POWERFlex®+ powered ambulance cot is capable of raising and lowering loads up to 318 kg (700 lb) at the touch of a button without operator assistance.

- ↳ X-Frame construction with rectangular tubing provides strength and durability
- ↳ Locked-on mattress provides easy patient transfer and security during roadside or aeromedical response
- ↳ Bed height range from 330 to 1040 mm (13 to 41 in.) with infinite range of adjustment
- ↳ Five-position, folding load frame and gas-assist backrest
- ↳ Adjustable lift bar at foot end
- ↳ Foot-end lead handle
- ↳ Cot can be operated manually if needed
- ↳ Four 150 mm (6 in.) swivel wheels
- ↳ US Voltage 110, International Voltage 220



- 1 Five-Position Load Frame and Multi-Position Foot-End Lift Bar** reduce the cot length by 559 mm (22 in.) for movement in confined spaces, and provide true 360° turning radius in the lowest position.
- 2 318 kg (700 lb) Lifting Capacity** raises the patient weight without lift assistance.
- 3 All-Metal Frame Construction** provides strength, long service life, and exceptional performance with heavy patients.
- 4 24 Volt DC POWERPac** with hydraulic actuator and dual-lifting cylinders provides smooth and reliable lifting.

5 Wide Thumb Controls provide effective gripping and control from a variety of positions with or without gloves.



6 Reflective Labeling provides nighttime visibility for added safety.



7 Eliminate Battery Management with in-the-fastener charging with the optional ICS[®] Integrated Charging System.

Specify charger voltage when ordering

- POWERFlexx+, Red, CE Marked #0054214
- POWERFlexx+, Blue, CE Marked #0054216
- POWERFlexx+, Red, CE Marked with ICS #0054215
- ICS Kit (Shallow Cup) #0000600

Accessories & Fasteners

P = Permanent **R** = Removable



Mattress
#0313997



417-1 Restraints
#0313915



430 Restraints
#0313892 (5')
#0313911 (7')



513-13 IV Pole
#0087172



514 Oxy-Clip
#0085500



274 PacRac™
#0818933



LBS Junior
#0822184
LBS #0822057



LBS Mattress
#0314025
LBS Jr. Mattress
#0314050



Charger
#0822426 (US)
#0822427 (UK)
#0822428 (Europe)
#0822429 (Australia)



Battery
#0822220

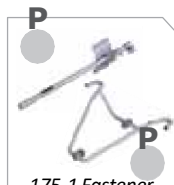

175-1 Fastener
#0001751F

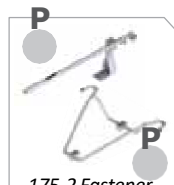

175-2 Fastener
#0001752F

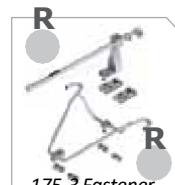

175-3 Fastener
#0001753F
175-4 Fastener
#0001754F

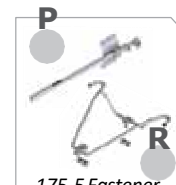

175-5 Fastener
#0001755F

SPECIFICATIONS

| | Length | Length | Width | Max Load | Weight | Load Limit | Load Limit | Shipping | Shipping |
|----------|---------|---------|--------|----------|--------|------------|-------------|----------|-----------------|
| | Max | Min | | Height | | Load Pos. | Lowest Pos. | Weight | L,W,H |
| Imperial | 83 in. | 61 in. | 24 in. | 34 in. | 133 lb | 700 lb | 1000 lb | 230 lb | 87x29x27 in. |
| Metric | 2108 mm | 1549 mm | 610 mm | 864 mm | 60 kg | 318 kg | 454 kg | 104 kg | 2210x737x686 mm |



Model 26P PROFlexx® Cot

- ↳ Advanced roll-in cot with two levels of height adjustment: fully elevated or ground level
- ↳ Scuff guards protect legs during loading and unloading
- ↳ Swing-down sidearms for convenient patient transfer from bed to cot
- ↳ Gas-assist backrest with infinite range of adjustment up to 66°
- ↳ Main frame features shock position
- ↳ Includes safety lock and leg lock



- 1 **All-Metal Frame Construction** with powder-coated tubing provides strength, long service life, and exceptional performance with heavy patients.
- 2 **Two Stationary Wheels and Two 360° Swivel Wheels** with wheel locks provide maximum maneuverability.
- 3 **Fold-Down Load Frame** shortens the length of the cot to accommodate movement in confined spaces.
- 4 **Gas-Assist Backrest** with infinite range of adjustment up to 66°.

Fold-Down Load Frame shortens the length of the cot to accommodate movement in confined spaces.



150 mm U-Tread Wheels maximize cot mobility.



Independent Folding Legs provide easy loading and unloading from an ambulance.

- Model 26P Cot, Blue, Mattress and Restraints.....#0054208
- Model 26P Cot, Red, Mattress and Restraints.....#20-0018-001
- Mattress.....#0313920

Accessories & Fasteners



417-1 Restraints
#0313915 (black)
#0313914 (orange)



430 Restraints
#0313892 (black 5')
#0313891 (orange 5')



513-10 IV Pole
#0087156



514 Oxy-Clip
#0085500



SPECIFICATIONS

| | Length | Length | Width | Folded Height | Loading Height | Weight | Limit | Shipping Weight | Shipping L,W,H |
|----------|------------|------------|--------|---------------|----------------|--------|--------|-----------------|---------------------|
| Imperial | Max 76 in. | Min 65 in. | 22 in. | 10.25 in. | 24 in. | 79 lb | 550 lb | 75 lb | 80 x 25 x 13 in. |
| Metric | 1930 mm | 1650 mm | 550 mm | 260 mm | 610 mm | 36 kg | 250 kg | 34 kg | 2030 x 640 x 390 mm |





Model 35X PROFlex[®] Cot

Ferno's 35X PROFlex[®] X-frame ambulance cot provides industry-leading stability and safety. A longer, fixed front leg in the X-frame and carefully engineered geometry create a low center of gravity and minimal flex.

- ↳ Rigid C-channel and fixed front legs provide stability when rolling patient
- ↳ Locked-on mattress provides easy patient transfer and security during roadside or aeromedical response
- ↳ Built-in shock frame and foot-end lead handle
- ↳ 150 mm (6 in.) U-Tread wheels with two wheel locks
- ↳ Safety U-Bar and Hook to hold cot inside ambulance as undercarriage is lowered when unloading
- ↳ One-hand swing-down sidearms
- ↳ Gas-assist backrest
- ↳ Nine height positions and three loading heights
- ↳ Black mattress and restraints included



- 1 **Five-Position Load Frame** provides better leverage for lifting and lowering and accommodates movement in confined spaces.
- 2 **Wider Bed Surface and Head Frame** provide comfort and support for any size patient and extra elbow room during intubation and CPR.
- 3 **All-Metal Frame Construction** provides strength, long service life, and exceptional performance with heavy patients.



4 **Telescoping Side Lift Handles** provide extra lifting points for operators to lift heavy patients or ease navigation over rough terrain.



5 **EZ Pull™ Release System** reduces wrist strain and helps you position yourself before assuming the weight of the cot, maintaining optimum lifting posture.



7 **Complete Bariatric Solution** with loadframe handlebar, 500 kg (1100 lb) load capacity in the lowest position, & optional LBS Bariatric Board (see page 54-57 for more bariatric solutions).

- 35X, Red, Mattress and Restraints #0015690
- 35X, Blue, Mattress and Restraints #0015693

Accessories & Fasteners

P = Permanent **R** = Removable



Mattress
#0313920



417-1 Restraints
#0313915 (black)



430 Restraints
#0313892 (blk, 5')
#0313911 (blk, 7')



513-13 IV Pole
#0087172



514 Oxy-Clip
#0085500



274 PacRac™
#0818933



Oxygen Holder
#0819958



LBS Junior
#0822184
LBS #0822057



LBS Mattress
#0314025
LBS Jr. Mattress
#0314050

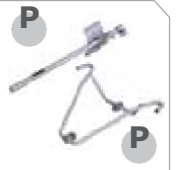

175-1 Fastener
#0001751F

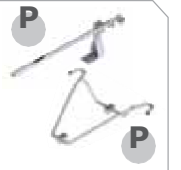

175-2 Fastener
#0001752F

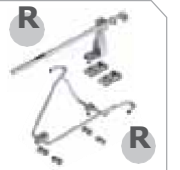

175-3 Fastener
#0001753F
175-4 Fastener
#0001754F

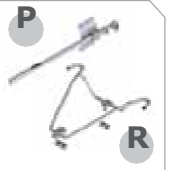

175-5 Fastener
#0001755F



StatTrac® Fastener
See Page 47

SPECIFICATIONS

| | Length Max. | Length Min. | Width | Height Max. | Height Min. | Max Load Height | Weight | Load Limit Load Pos. | Load Limit Lowest Pos. | Shipping Weight | Shipping L,W,H |
|----------|-------------|-------------|--------|-------------|-------------|-----------------|--------|----------------------|------------------------|-----------------|-----------------|
| Imperial | 79 in. | 64 in. | 24 in. | 40 in. | 14 in. | 35 in. | 92 lb | 700 lb | 1100 lb | 135 lb | 84x28x23 in. |
| Metric | 2010 mm | 1620 mm | 610 mm | 1020 mm | 350 mm | 890 mm | 42 kg | 317 kg | 500 kg | 61 kg | 2134x711x584 mm |





Pictured with Optional Lift Handles

Model 28Z PROFlexx[®] Chair Cot

The 28Z PROFlexx[®] Chair Cot provides maximum versatility in confined areas. The maneuverability and flexibility of transforming from cot to chair allows you to respond in confined spaces such as tight hallways, narrow staircases, and small elevators without transferring the patient. The 28Z's light weight, superior stability, and load capacity reduce situations that may cause injury to you or your patient.

- Ì 3 positions with easy transition from cot to chair
- Ì Lightweight roll-in style cot is only 31 kg (69 lb), making it easy to handle
- Ì Locked-on mattress provides easy patient transfer and security during roadside or aeromedical response
- Ì All-metal aluminum frame construction provides strength, long service life, and better performance with heavy patients
- Ì Only 1220 mm (48 in.) length in chair position provides high maneuverability

- 28Z, Red, Mattress and Restraints #0012805
- 28Z, Blue, Mattress and Restraints #0012808
- 28Z, Red, Mattress, Restraints, Lower Tray #0012810
- 28Z, Blue, Mattress, Restraints, Lower Tray #0012813

Fasteners

Compatible with Model 173 Fasteners.
Please refer to pages 46 & 47.

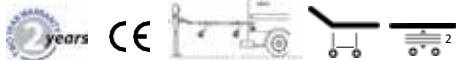

Accessories



28Z Mattress Set
#0314031



417-1 Restraints
#0313915 (black)

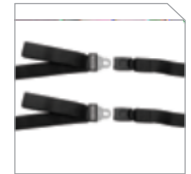

430 Restraints
#0313892 (blk, 5')



513-11 IV Pole
#0087157



514-1 Oxy-Clip
#0085520



274-SPacRac™
#0818952



Long Lift Handles
#0822136



Short Lift Handles
#0822137



Lead Handle
#0822139

SPECIFICATIONS

| | Cot Height Max | Cot Height Min | Loading Height | Length Folded | Length Raised | Overall Width | Chair Height | Chair Max Depth | Chair Weight | Load Limit | Shipping Weight | Shipping L,W,H |
|----------|-------------------|-------------------|-------------------|------------------|------------------|------------------|-----------------|--------------------|-----------------|---------------|--------------------|-------------------|
| Imperial | 33 in. | 9 in. | 27 in. | 80 in. | 75 in. | 25 in. | 55 in. | 48 in. | 82 lb | 700 lb | 120lb | 83x26x12in. |
| Metric | 840 mm | 220 mm | 680 mm | 2040 mm | 1900 mm | 630 mm | 1400 mm | 1220 mm | 37 kg | 318 kg | 54kg | 2108x660x305mm |



Model 93H PROFlexx[®] Cot

The 93H PROFlexx[®] provides the highest stability of any H-frame ambulance cot on the market. The difference is the unique transport position, which maintains a lower center of gravity when transporting patients.

- ↳ Sturdy H-frame construction with large powder-coated aluminum tubing provides stability
- ↳ Locked-on mattress provides easy patient transfer and security during roadside or aeromedical response
- ↳ Built-in shock frame and fully adjustable gas-assist backrest enhance patient care
- ↳ Multi-position head-end drop frame provides improved maneuvering in tight spaces and better leverage for short users when lifting and loading
- ↳ All-metal frame construction provides strength, long service life, and better performance with heavy patients
- ↳ Five height positions

93H, Red, Mattress and Restraints#0015762
 93H, Blue, Mattress and Restraints#0015763

Fasteners

Compatible with Model 175 Fasteners.
 Please refer to pages 46 & 47.



5

Accessories

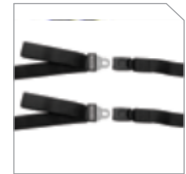

Mattress

#0313020



417-1 Restraints

#0313915 (black)



430 Restraints

#0313892 (blk, 5')



513-13 IV Pole

#0087172



514 Oxy-Clip

#0085500



274 PacRac[™]

#0818933

LBS Junior

#0821936

LBS #0819991

LBS Mattress #0314025

LBS Jr. Mattress

#0314050

SPECIFICATIONS

| | Length | Length | Width | Height | Height | Height | Height | Loading | Load | Shipping | Shipping | |
|----------|---------|---------|--------|--------|--------|-----------|-----------|---------|--------|----------|----------|-----------------|
| | Max | Min | | Max | Min | Mid-Level | Low-Level | Height | Weight | Limit | Weight | L,W,H |
| Imperial | 83 in. | 67 in. | 24 in. | 36 in. | 11 in. | 28 in. | 21 in. | 30 in. | 98 lb | 650 lb | 146 lb | 88x28x25 in. |
| Metric | 2108 mm | 1701 mm | 610 mm | 914 mm | 279 mm | 711 mm | 533 mm | 762 mm | 45 kg | 295 kg | 66 kg | 2235x711x635 mm |



F2 Transporter & Stretcher

- ↳ Independent leg operation provides safe loading into the ambulance and legs unfold automatically for easy unloading
- ↳ Color-coded controls are easy to use and require minimal training
- ↳ Two loading heights: 500 mm and 560 mm (20 in. and 22 in.)
- ↳ Lift-off stretcher features reversible patient loading
- ↳ Large 200 mm (8 in.) wheels easily roll over any terrain
- ↳ Foot-end swivel-lock wheels and head-end fixed wheels with wheel locks
- ↳ Shock frame and contour frame
- ↳ Four telescoping carrying handles with three locking positions
- ↳ Adjustable backrest with 8 positions up to 90°
- ↳ Optional swing-down sidearms
- ↳ 100% mechanical, low-maintenance cot
- ↳ Conforms to International Standards EN 1789 and EN 1865

- F2 Transporter.....#0054225
- F2 Stretcher 4 part.....#0153238
- F2 Stretcher 5 part.....#0153239

Accessories & Fastener



Instrument Tray
#0832158



IV Pole
#0090015



Sidearms
#0832154



Foot Support
#0832155



Three-Point Fastener
#0573081

SPECIFICATIONS

| | Length Min | Length Max | Width | Height Min | Height Max | Load Height 1 | Load Height 2 | Weight | Load Limit | Shipping Weight | Shipping L, W, H, |
|-----------------|---------------|---------------|--------|---------------|---------------|------------------|------------------|---------|---------------|--------------------|----------------------|
| Transp. Imp. | 78 in. | 78 in. | 23 in. | | | 20 in. | 22 in. | 61 lb | 551 lb | 73 lb | 75x24x14 in. |
| Transp. Metric | 1969 mm | 1969 mm | 578 mm | | | 500 mm | 560 mm | 27.5 kg | 250 kg | 33 kg | 1910x610x360 mm |
| Stretch. Imp. | 75 in. | 89 in. | 22 in. | | | | | 41 lb | 551 lb | 45 lb | 75x24x9 in. |
| Stretch. Metric | 1900 mm | 2267 mm | 570 mm | | | | | 18.4 kg | 250 kg | 20.5 kg | 1910x600x240 mm |





F2 Monobloc

- ↳ Independent-Leg operation provides safe loading into the ambulance and legs unfold automatically for easy unloading
- ↳ Color-coded controls are easy to use and require minimal training
- ↳ Two loading heights: 500 mm and 560 mm (20 in. and 22 in.)
- ↳ Large 200 mm (8 in.) wheels easily roll over any terrain
- ↳ Foot-end swivel lock wheels and head-end fixed wheels with wheel locks
- ↳ Shock frame and contour frame
- ↳ Four telescoping carrying handles with three positions
- ↳ Adjustable backrest with 8 positions up to 90°
- ↳ Optional swing-down sidearms
- ↳ 100% mechanical, low-maintenance cot
- ↳ Aluminum construction
- ↳ Comes with telescoping IV pole and four-section mattress
- ↳ Conforms to International Standards EN 1789 and EN 1865

- F2 Monobloc 4 Part.....#0054233
- F2 Monobloc 5 Part.....#0054234

Accessories & Fastener



Instrument Tray
#0832158



IV Pole
#0090015



Sidearms
#0832154



Foot Support
#0832155

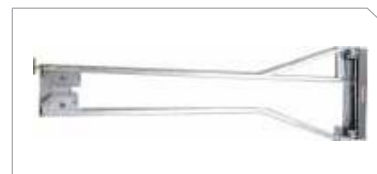

Three-Point Fastener
#0573081

SPECIFICATIONS

| | Length Min | Length Max | Width | Height Min | Height Max | Load Height 1 | Load Height 2 | Weight | Load Limit | Shipping Weight | Shipping L,W,H |
|-------------|---------------|---------------|--------|---------------|---------------|------------------|------------------|--------|---------------|--------------------|-------------------|
| MB Imperial | 76 in. | 89 in. | 22 in. | 11 in. | 32 in. | 20 in. | 22 in. | 79 lb | 551 lb | 95 lb | 75x24x14 in. |
| MB Metric | 1915 mm | 2269 mm | 560 mm | 272 mm | 807 mm | 500 mm | 560 mm | 36 kg | 250 kg | 43 kg | 1910x610x360 mm |



Harrier® LT

The Harrier LT is a light-weight powered ambulance trolley, configurable to differing needs and requirements. Options include various handle options for improved maneuverability and a variety of accessories designed to improve the ease of use of the trolley, reducing manual handling injuries.

- ↳ Lightweight trolley, from 69 kg (152 lb)
- ↳ Excellent maneuverability, combining optimal low-friction wheels with ergonomic operator push-poles (optional accessory)
- ↳ Powered up/down lift operation, with slow start-stop movement, for complete patient comfort and operator safety
- ↳ Load capacity of 350 kg (772 lb) in raised position, 400 kg (882 lb) when in lowered position
- ↳ Simplified high-performance battery management. Uses a detachable rechargeable 28V 3A Milwaukee battery, 77 lifts from 1 single charge, recharge time of less than 1 hour
- ↳ IPC compliant, incorporating anti-microbial paint finish, use of Silver Biosafe harness restraints and an easy-to-clean 2-section, Anti-Bacterial Pressure-Relief mattress
- ↳ Reflective strips on top, base and X-frame rails, for increased visibility at night
- ↳ Compatible with Ferno Two Part Locking System



Harrier LT

Harrier® LT

- Harrier LT, 2-Part Lock, AB-PR Mattress with AB-Velcro fixing, Biosafe Harness & Detachable Vertical Push Poles#H1B2-H-1-10C
- Harrier LT, NMI Lock, AB-PR Mattress with AB-Velcro fixing, Biosafe Harness & Detachable Vertical Push Poles#H1B2-H-3-10C
- 2-Section AB-PR Mattress#038288300

Harrier® LT-LBS

- ↳ Same features of the Harrier LT, but includes extending sides for carrying larger-mass patients
- Harrier LT-LBS, 2-Part Lock, AB-PR Mattress with AB-Velcro fixing, Biosafe Harness, Long Cotsides & Vertical Poles#H1E2-H-1-9D
- Harrier LT-LBS, NMI Lock, AB-PR Mattress with AB-Velcro fixing, Biosafe Harness, Long Cotsides & Vertical Poles#H1E2-H-3-9D
- 2-Section AB-PR Mattress w/ Standard Sidearms#038288350
- 2-Section AB-PR Mattress w/ Inflatable Sidearms & Pump. #038288450



Harrier LT-LBS



Ferno Two Part Locking System

SPECIFICATIONS

| | Length Min | Length Max | Width Min | Width Max | Height Min | Height Max | Weight | Load Limit | Load Limit Low Pos. |
|---------------------|---------------|---------------|--------------|--------------|---------------|---------------|---------|---------------|------------------------|
| Harrier LT Imper. | 63 in. | 76 in. | 22 in. | | 19 in. | 36 in. | 153 lb | 772 lb | 882 lb |
| Harrier LT Metric | 1610 mm | 1930 mm | 570 mm | | 480 mm | 925 mm | 69 kg + | 350 kg | 400 kg |
| Harrier LT-LBS Imp. | 63 in. | 76 in. | 22 in. | 38 in. | 19 in. | 36 in. | 187 lb | 772 lb | 882 lb |
| Harrier LT-LBS Met. | 1610 mm | 1930 mm | 570 mm | 955 mm | 480 mm | 925 mm | 85 kg | 350 kg | 400 kg |





CCT Critical Care Trolley

The proven range of Ferno Critical Care Trolleys provide an instant patient treatment surface for transportation into a hospital. The trolleys have been tested and certified in a fully loaded simulation, in accordance with BS EN 1789:2007.

Features include:

- ↳ Backrest easily adjusted up to 75° via assisted lift
- ↳ Leg elevation and knee raise included as standard
- ↳ Two cylinder holders plus storage cabinet options available
- ↳ Single push/pull handle at foot end
- ↳ Removable four-point harness, plus two patient restraints
- ↳ IPC compliant, incorporating anti-microbial paint finish, use of Silver Biosafe harness restraints and an easy-to-clean 2-section, Anti-Bacterial Pressure-Relief mattress
- ↳ Dynamically tested to 10G in 6 directions
- ↳ Compatible with Ferno Two Part Locking System
- ↳ All CCT trolleys have the capability of securing a range of medical devices, and are configurable to specific customer's needs

CCT-P

↳ Standard Critical Care Trolley

CCT-P #005103500

CCT-M

↳ Bariatric Critical Care Trolley

↳ Includes extendable sidearms

CCT-M #005103600

CCT-BP

↳ Critical Care Trolley, capable of carrying Intra-Aortic Balloon Pump

Optional Features:

- ↳ Footstool secured with straps (200 mm)
- ↳ Tail lift feature to aid loading/unloading the balloon pump and secure device in position

CCT-BP #005103700

CCT-ECMO

↳ Critical Care Trolley, for carrying Extra Corporeal Membrane Oxygenation

↳ Tail lift feature to aid loading/unloading the device and secure in position

CCT-ECMO #005103700

2-Section AB-PR Mattress w/ Standard Sidearms #038288350

2-Section AB-PR Mattress w/ Inflatable Sidearms & Pump .. #038288450

SPECIFICATIONS



| | Length | Width Min | Width Max | Height | Weight | Load Limit |
|----------------------|---------|--------------|--------------|----------|---------|---------------|
| CCT-P Imperial | 76 in. | 22 in. | | 31 in. | 168 lb | 399 lb |
| CCT-P Metric | 1930 mm | 555 mm | | 780 mm | 76.3 kg | 181 kg |
| CCT-M Imperial | 75½ in. | 24 in. | 40 in. | 31.5 in. | 174 lb | 551 lb |
| CCT-M Metric | 1918 mm | 605 mm | 1025 mm | 800 mm | 79 kg | 250 kg |
| CCT-BP/ECMO Imperial | 80 in. | 22 in. | | 35 in. | 176 lb | 399 lb |
| CCT-BP/ECMO Metric | 2040 mm | 555 mm | | 880 mm | 80 kg | 181 kg |



Bariatric EZ Glide® from Ferno UK
More Information on Page 55

Model 59T EZ Glide® Stair Chair

The EZ Glide® Chair can be used as a stair chair, evacuation chair, and transport chair.

↳ Two rear tracks contact the lip of stairs allowing the tracks to glide over the edge of each step, eliminating the need to lift the chair and patient

↳ All-metal frame construction carries up to 227 kg (500 lb) to accommodate a wide range of patient sizes

↳ Two 100 mm (4 in.) front swivel wheels and two 150 mm (6 in.) rear wheels with locks do not collect debris and provide maneuverability in confined spaces such as stair landings

↳ Superior maneuverability in confined spaces and over carpet with 25.4 mm (1 in.) track-to-ground clearance and frontswivel-wheels

↳ Five-position rear control bar (from 950 to 1613 mm / 37.5 to 63.5 in.)

↳ Five-position front telescoping handles (from 137 to 483 mm / 5.4 to 19 in.)

↳ Snap-on ABS plastic panels are easily removed for cleaning

↳ Extending footrest

↳ Available in red, blue, and platinum

EZ Glide with Restraints, Red #0731335

EZ Glide with Restraints, Blue #0731338

EZ Glide with Restraints, Platinum #0731339

Accessories: Page 40, 42



1 Extending Footrest and lower track angle increase patient sense of security.

2 Folding Design provides compact storage.

3 5-Position Rear LiftBar and front telescoping handles reduce the strain of lifting and provide maximum control for operators of various heights.



SPECIFICATIONS

| | Height Min. | Overall Width | Seat Width | Depth Max. Open | Depth Min. Open | Folded L, W, Thickness | Weight | Load Limit | Shipping Weight | Shipping L, W, H |
|----------|-------------|---------------|------------|-----------------|-----------------|------------------------|--------|------------|-----------------|------------------|
| Imperial | 37.5 in. | 20 in. | 16.5 in. | 51 in. | 28.5 in. | 37½x20x10 in. | 33 lb | 500 lb | 40 lb | 40x21x9 in. |
| Metric | 953 mm | 516 mm | 419 mm | 1295 mm | 724 mm | 953x516x254 mm | 15 kg | 227 kg | 18 kg | 1010x530x230mm |



EZ Glide® with PowerTraxx® Stair Chair

- ↳ Assists patient loads up to 227 kg up and down stairs without carrying or lifting
- ↳ The motor and track system carry the weight, reducing fatigue and the chance for injury
- ↳ Provides maximum safety when going up and down stairs, using an electronically controlled motor and direct drive transmission
- ↳ Fast climbs and descents using a variable-speed system
- ↳ Easily stop, climb, or descend stairs with just a push of a paddle button
- ↳ Maximum performance on every call with intelligent microprocessor electronics
- ↳ Superior maneuverability in confined spaces and over carpet with 25.4 mm (1 in.) track-to-ground clearance and frontswivel-wheels
- ↳ Full control of operation with a manual override that allows medics to use in unpowered mode
- ↳ Smooth 100 mm (4 in.) front swivel wheels and 150 mm (6 in.) rear wheels do not collect debris and provide maneuverability in confined spaces such as stair landings

| EZ Glide with PowerTraxx | Red | Blue | Platinum | RetrofitKit |
|--------------------------|---------|---------|----------|-------------|
| 120V | 0731374 | 0731375 | 0731376 | 0832195 |
| 240V | 0731383 | 0731384 | 0731385 | 0832196 |

Accessories: Pages 40, 42

1 Easy-to-Use Paddle Style Controls

are intuitive and provide easy operation when climbing or descending stairs.



2 Motor and Direct Drive

transmission provide maximum safety on stairs.



3 Rechargeable

Lithium-Ion Battery is easy to remove. #0832198



CE

SPECIFICATIONS

| | Height | Overall | Seat | Depth | Depth | Folded | Load | Shipping | Shipping | |
|----------|----------|---------|----------|----------|----------|-----------------|----------|----------|----------|-----------------|
| | Min | Width | Width | Max Open | Min Open | L, W, Thickness | Weight | Weight | L, W, H | |
| Imperial | 37.5 in. | 20 in. | 16.5 in. | 51 in. | 28.5 in. | 37½x20x10 in. | 56.6 lb. | 500 lb | 64 lb | 9x22x41 in. |
| Metric | 953 mm | 516 mm | 419 mm | 1295 mm | 724 mm | 953x516x254 mm | 25.67 kg | 227 kg | 29 kg | 240x570x1040 mm |

Model 40 Stair Chair

- ↳ Easy to maneuver by two EMTs in confined quarters
- ↳ Two 127 mm (5 in.) stationary rear wheels
- ↳ Telescoping front handles with two positions and two rear handles
- ↳ Vinyl-coated nylon cover is simple to clean and resists stains, blood and bodily fluids
- ↳ Two 2134 mm (7 ft.) quick-release patient restraints and leg restraints hold the patient securely
- ↳ Chair can be mounted to interior or exterior walls
- ↳ Ideal for high-rise buildings or industrial settings
- ↳ Available in burgundy and orange



- Model 40 with Vinyl Cover, Orange #0714865
- Model 40 with Vinyl Cover, Burgundy #0714864

CE

Model 42/48 Stair Chairs

- ↳ Designed to be stored in small spaces
- ↳ Functions well in confined spaced such as narrow hallways and multiple-landing stairways
- ↳ Two 102 mm (4 in.) rear stationary wheels and two 51 mm (2 in.) low-profile, front guide wheels
- ↳ Rolls over most carpeted or hard surfaces
- ↳ Four lifting handles with non-slip hand grips
- ↳ Soft vinyl-coated cover is simple and easy to clean, resists blood, stains, and bodily fluids
- ↳ Features a locking safety latch
- ↳ Two 2134 mm (7 ft.) quick-release patient restraints and leg restraints hold the patient securely

Model 42 Stair Chair is available with durable, easy-to-clean, soft vinyl cover. Available in burgundy and orange.

- Model 42 with Vinyl Cover, Orange #0714867
- Model 42 with Vinyl Cover, Burgundy #0714868

Model 48 Stair Chair is identical to the Model 42, but is three inches narrower. Available with soft vinyl cover. The Model 48 is ideal for use in airplanes, boats, restaurants, and all areas where access is severely limited.

- Model 48 with Vinyl Cover, Orange #0714800
- Model 48 with Vinyl Cover, Burgundy #0714803

19" wide



16" wide



CE

SPECIFICATIONS

| | Height | Width | Depth Handles Ext. | Depth Hand. Folded | Folded Length | Folded Depth | Weight | Load Limit | Shipping Weight | Shipping L,W,H |
|-------------|--------|--------|-----------------------|-----------------------|------------------|-----------------|--------|---------------|--------------------|-------------------|
| 40 Imperial | 36 in. | 20 in. | 46 in. | 27 in. | 36 in. | 7 in. | 19 lb | 350 lb | 24 lb | 38x21x8 in. |
| 40 Metric | 910 mm | 510 mm | 1150 mm | 690 mm | 910 mm | 180 mm | 8.6 kg | 159 kg | 11 kg | 965x533x203 mm |
| 42 Imperial | 37 in. | 19 in. | 34 in. | 24 in. | 25 in. | 6 in. | 19 lb | 350 lb | 23 lb | 26x20x7 in. |
| 42 Metric | 950 mm | 490 mm | 860 mm | 610 mm | 630 mm | 160 mm | 9 kg | 159 kg | 10 kg | 660x508x178 mm |
| 48 Imperial | 37 in. | 16 in. | 34 in. | 24 in. | 25 in. | 6 in. | 18 lb | 350 lb | 23 lb | 26x20x7 in. |
| 48 Metric | 950 mm | 400 mm | 860 mm | 610 mm | 630 mm | 160 mm | 8 kg | 159 kg | 10 kg | 660x508x178 mm |

Compact 2 TrackChair

With all of the features of the standard carry chair, the Compact 2 Track Chair has capability of attaching a track, for use when transporting a patient down stairs.

- ↳ Traditional Compact 2 Carry Chair design, but with an attachable track
- ↳ Track attaches easily to chair
- ↳ Track is removable to minimize the weight of equipment that needs to be carried by operators
- ↳ Adjustable rear handle accommodates operators of different heights
- ↳ Stores in vehicle within same space envelope as standard Compact 2
- ↳ Uses anti-bacterial BioSafe restraints and leg straps
- ↳ Easy to transfer chair up and down vehicle ramps

Compact 2 TrackChair.....#071481450



Compact 2 Carry Chair

The Compact 2 Carry Chair is manufactured from stainless steel for strength and durability and is designed to enhance patient transfers in confined areas.

- ↳ The one-piece back and seat cover allows the patient to sit in a comfortable position
- ↳ The flame -etardant, vinyl-coated nylon can be wiped clean for maximum hygiene and can be removed for cleaning or replacement
- ↳ Folds neatly into a compact size for easy storage
- ↳ Large 178 mm (7 in.) wheels and axle bar help provide stability when wheeling the patient over uneven ground
- ↳ Easily mounts on a wall with an optional wall bracket and dust cover
- ↳ Also available with an optional zipped carry case

Compact 2 Carry Chair.....#071481401/S

Compact 2 Carry Case.....#031350600

Compact 2 Wall Bracket.....#081931400

Compact 2 Dust Cover.....#038299401



SPECIFICATIONS

| | Height Min | Height Max | Width | Depth | Depth Folded | Total Weight | Load Limit |
|----------------------|---------------|---------------|--------|--------|-----------------|-----------------|---------------|
| Compact 2 Imper. | | 37 in. | 18 in. | 17 in. | 11 in. | 20 lb | 441 lb |
| Compact 2 Metric | | 935 mm | 445 mm | 420 mm | 285 mm | 9 kg | 200 kg |
| Comp. 2 TrackImper. | 42 in. | 57 in. | 18 in. | 37 in. | 12 in. | 33 lb | 441 lb |
| Comp. 2 Track Metric | 1062 mm | 1445 mm | 450 mm | 950 mm | 295 mm | 14.9 kg | 200 kg |

Utila Chair Model ALS 103

This standard chair model is also the most popular one among customers. All Utila chairs include two patient restraints.

- ↳ Strong and durable aluminum construction for long service life
- ↳ White powder-coated finish (also available in RAL-colors) prevents oxidation for clean hands and clothing
- ↳ Anatomically-shaped seat and backrest
- ↳ Easy-to-clean synthetic leather can be disinfected
- ↳ Two rear telescoping handles with anti-slip plastic coating
- ↳ Two rear folding handles with anti-slip plastic coating
- ↳ Two front telescoping handles with anti-slip plastic coating
- ↳ Swing up padded armrests
- ↳ Telescoping footrest with anti-slip plastic coating
- ↳ Two stationary and two swivel wheels (150 mm/6 in.) with wheel locks
- ↳ Conforms to International Standards EN 1789 and EN 1865
- ↳ Equipped with two pins for locking into floor mount
Utila Model BH 501



Shown with Optional
Shoulder Harness Restraint

Order from Utila
Tel: +49 0 2241 94830
Website: www.utila.de



Utila Chair Model ALS 300

The ALS 300 is similar to the ALS103 but weighs only 15 kg (33 lb). Therefore it is easy to handle, and it is strong and stable.

- ↳ Strong and durable aluminum construction for long service life
- ↳ White powder-coated finish (also available in RAL-colors) prevents oxidation for clean hands and clothing
- ↳ Anatomically-shaped seat and backrest
- ↳ Easy-to-clean synthetic leather can be disinfected
- ↳ Two rear telescoping handles with anti-slip plastic coating (optional)
- ↳ Two rear folding handles with anti-slip plastic coating
- ↳ Two front telescoping handles with anti-slip plastic coating
- ↳ Swing up padded armrests
- ↳ Telescoping footrest with anti-slip plastic coating
- ↳ Two stationary and two swivel wheels (150 mm/6 in.) with wheel locks
- ↳ Conforms to International Standards EN 1789 and EN 1865
- ↳ Equipped with two pins for locking into floor mount
Utila Model BH 501



Order from Utila
Tel: +49 0 2241 94830
Website: www.utila.de



SPECIFICATIONS

| | Length Handles Ext. | Length Handles Retract. | Width | Height | Seat Height | Weight | Load Limit |
|------------------|------------------------|----------------------------|--------|---------|----------------|---------|------------|
| ALS 103 Imperial | 59 in. | 31½ in. | 22 in. | 43 in. | 14.5 in. | 52 lb | 331 lb |
| ALS 103 Metric | 1500 mm | 800 mm | 570 mm | 1100 mm | 370 mm | 23.5 kg | 150 kg |
| ALS 300 Imperial | 57 in. | 29½ in. | 22 in. | 44½ in. | 19 in. | 33 lb | 331 lb |
| ALS 300 Metric | 1440 mm | 750 mm | 560 mm | 1130 mm | 480 mm | 15 kg | 150 kg |

Utila Chair Model ALS 400 S

The ALS 400 S has the same features as all of the Utila chairs, but folds for storage inside the ambulance.

- ↳ Strong and durable aluminum construction for long service life
 - ↳ White powder-coated finish (also available in RAL-colors) prevents oxidation for clean hands and clothing
 - ↳ Anatomically-shaped seat and backrest
 - ↳ Folds for easy storage
 - ↳ Easy-to-clean synthetic leather can be disinfected
 - ↳ Two rear telescoping handles with anti-slip plastic coating
 - ↳ Two rear folding handles with anti-slip plastic coating
 - ↳ Two front telescoping handles with anti-slip plastic coating
 - ↳ Swing up padded armrests
 - ↳ Telescoping footrest with anti-slip plastic coating
 - ↳ Two stationary and two swivel wheels (150 mm/6 in.) with wheel locks
 - ↳ Conforms to International Standards EN 1789 and EN 1865
 - ↳ Equipped with two pins for locking into floor mount
- Utila Model BH 501



Order from Utila
 Tel: +49 0 2241 94830
 Website: www.utila.de



Utila Chair Model LTS 700

The LTS 700 can be used to transport a patient in a sitting position and also in a more comfortable flat position with the backrest folded down.

- ↳ Strong and durable aluminum construction for long service life
 - ↳ White powder-coated finish (also available in RAL-colors) prevents oxidation for clean hands and clothing
 - ↳ Anatomically-shaped seat and backrest
 - ↳ Easy-to-clean synthetic leather can be disinfected
 - ↳ Two rear telescoping handles with anti-slip plastic coating
 - ↳ Two rear folding handles with anti-slip plastic coating
 - ↳ Two front telescoping handles with anti-slip plastic coating
 - ↳ Swing up padded armrests
 - ↳ Telescoping footrest with anti-slip plastic coating
 - ↳ Two stationary and two swivel wheels (150 mm/6 in.) with wheel locks
 - ↳ Conforms to International Standards EN 1789 and EN 1865
 - ↳ Equipped with two pins for locking into floor mount
- Utila Model BH 501



Order from Utila
 Tel: +49 0 2241 94830
 Website: www.utila.de



SPECIFICATIONS

| | Length Handles Ext. | Length Handles Retract. | Width | Height | Seat Height | Weight | Load Limit |
|------------------|------------------------|----------------------------|--------|---------|----------------|--------|------------|
| ALS 103 Imperial | 59 in. | 37 in. | 22 in. | 45 in. | 18 in. | 44 lb | 331 lb |
| ALS 103 Metric | 1500 mm | 950 mm | 560 mm | 1140 mm | 450 mm | 20 kg | 150 kg |
| ALS 300 Imperial | 67 in. | 37 in. | 22 in. | 46 in. | 19 in. | 51 lb | 331 lb |
| ALS 300 Metric | 1700 mm | 940 mm | 570 mm | 1160 mm | 490 mm | 23 kg | 150 kg |

Oxy-Clip2™ Spring-Loaded Oxygen Bottle Holder

- Ì Compatible with the EZ Glide® Stair Chair series
- Ì Spring-loaded mechanism for quick attachment and removal
- Ì Will hold D-sized oxygen bottle in place during transport, freeing the operator's hands to focus on patient care
- Ì Made of lightweight aluminum with nylon webbing and zinc die-cast/nickel-plated D-ring fasteners

Oxy-Clip2 for 59T#0821977



Head-End O2 Bracket

- Ì Easily attaches to the backrest panel of a Ferno cot to keep the oxygen cylinder close to the patient's head
- Ì Quickly and securely holds "D" and "Jumbo D" size oxygen cylinders

Head-End O2 Bracket#0822111



Oxygen Cylinder Holder

- Ì Compatible with 35X PROFlexx® series ambulance cots
- Ì Will hold a "D" size, "Jumbo-D", or a FernO2 DD-Lite

Oxygen Cylinder Holder for 35X#0819958



Oxy-Clip™ Cylinder Holder

- Ì Fits on the cot sidearm (19 mm/.75 in. diameter)
- Ì Securely holds either steel or aluminum "D" size cylinders (will not accept Jumbo "D" size cylinder)
- Ì Spring-loaded latch enables it to instantly attach to the sidearm
- Ì When transferring the patient to the hospital bed, the Oxy-Clip™ rotates down and out of the way as the cot sidearm is lowered

Model 514 Oxy-Clip for Models
25, 26, 35, 93, 4140, 4150, Mondial RS Stretchers#0085500
Model 514-1 for Model 28#0085520



Mondial® Series IV Poles

- ↳ Three-stage design with adjustable height for placement of IV solutions at appropriate levels
- ↳ Permanently mounts to cot main frame or lift-off stretcher
- ↳ Hook-and-loop straps stabilize IV containers
- ↳ Folds down for storage

Mondial Monobloc IV Pole#0832197

Mondial RS Mount IV Pole#0090016

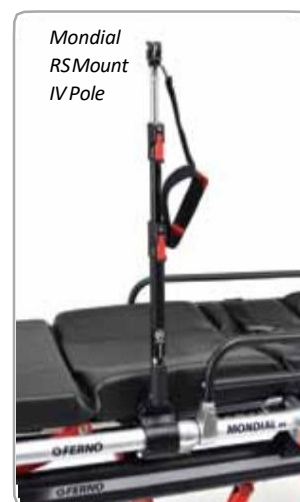

Model 513-10 Series Heavy-Duty IV Poles

- ↳ Permanently mounts to cot main frame
- ↳ Adjustable height for placement of IV solutions at appropriate levels
- ↳ 513-10 pole is nonmagnetic for MRI use
- ↳ Capable of holding four one-liter containers of fluid and two transport IV pumps
- ↳ Large hook-and-loop straps stabilize IV containers
- ↳ Folds along the side of the cot mattress for easy storage (excluding Model 513-11)
- ↳ Lock sleeve secures pole in upright position

Model 513-10 is compatible with Models 25, 26, 30, 35, 93, POWERFlex®, 30-NM, 33-NM, and 35-ANM Cots. Length 33"-48"

Model 513-10 HD NM#0087156

Model 513-11 is specifically made for Ferno-Flex™ Model 28 and 28Z Cots. Mounts to rectangular main frame. Length 29"-44"

Ferno-Flex™ Model 513-11 HD NM#0087157

Model 513-13 is compatible with Models 25, 26, 30, 35 Series, 93 Series, and POWERFlex® Cots. Length 24"-38"

Model 513-13#0087172

Model 513-LBS is designed for use with the LBS and LBS Jr.

Model 513-LBS#0087173



Model 513-10

Model 513-11

Model 513-13

Model 2030 IV Pole

- ↳ Permanently attaches within the sidearm of most Ferno cots
- ↳ Comes complete with a new sidearm for quick and easy fitting
- ↳ Mounts to patient's left side of cot only

Model 2030 IV Pole#LAIV-2030





Model 274 PacRac™
 For 93H, 35X, POWERFlex #0818933
 For 28 and 28Z #0818952



PacRac™+
 For Mondial Series #FWEPR



Equipment Bracket
 Model 2020 Equipment Bracket #CA5250
 (not compatible with Model 28 or 28Z cots)



28Z Swing-Out Lift Handles
 178 mm (7 in.) Handles #0822137



28Z Swing-Out Lift Handles
 254 mm (10 in.) Handles #0822136



28Z Lead Handle
 28Z Lead Handle #0822139



Sof-Net Head-End Storage
 For 93H, 35X, POWERFlex #0821996
 For 28Z #0822178



EZ Glide® Secure Mount
 EZ Glide Secure Lock Mount #0822072



EZ Glide® Wall Mount
 EZ Glide WallMount #0822096



EZ Glide® IV Pole
 EZ Glide IV Pole #0821976



EZ Glide® Hard Headrest with Pouch
 EZ Glide Hard Headrest Kit #0822430



Model 417-1 Harness Restraint

- Ì Primary-user restraint
- Ì Four individually-adjustable straps
- Ì Quick-release chrome-plated metal buckle
- Ì Should be used in conjunction with two Ferno® Model 430 Patient Restraints
- Ì Available in black or orange

Model 417-1, Black #0313915
 Model 417-1, Orange #0313914
 Model 417-EFX, For EFX Stretchers, Black #0313996



Model 430 Series Cot Restraints

- Ì Primary-use patient restraints made of 51 mm (2") nylon webbing
- Ì Quick-release automotive-type chrome-plated male and black-painted female metal buckle with push-button release
- Ì Resists rust and corrosion
- Ì Male strap is adjustable and hemmed on the end
- Ì Available in black or orange
- Ì Available in 1524 mm (5'), 2134 mm (7') and 2743 mm (9')



| | Black | Orange |
|---------|----------|----------|
| 2pc. 5' | #0313892 | #0313891 |
| 2pc. 7' | #0313911 | #0313912 |
| 1pc. 7' | #0313910 | #0313887 |
| 1pc. 9' | | #0313889 |

Model 414-OL Wrist Restraint

- Ì Adjustable to hold patient's wrists securely in lap
 - Ì Fastens to both sides of the cot with hook-and-loop closures
- Model 414-OL, Set of 2, Orange #0312320



Model 414-R Wrist Restraints

- Ì Restraints hold the patient's wrist to the top of the cot's sidearms
 - Ì Hook-and-loop closures
- Model 414-R, Set of 2, Orange #0312310



Model 415 Ankle Restraint

- Ì Fastens to both sides of the cot's main frame to secure ankles
 - Ì Restraint allows each leg to be individually secured or released
- Model 415-R, Orange #0312330

Universal Psychiatric Restraint Set

- Ì Includes 2 single wrist cuffs and a double ankle cuff strapping system
 - Ì Each cuff features a padded, double overlap strap system secured with hook-and-loop closures
 - Ì Adjustable tie down loop for flexible attachment and quick-connect buckles with adjustable length
- Universal Psychiatric Restraint Set #BRH-MPR



Model 352 Acrylic-Blend Blanket

Ì 100% Fiber woven material (acrylic) is stitched around perimeter to withstand repeated washings

Ì Measures 1829 x 2286 mm (72 x 90 in.)

Ì Machine wash and dry

Model 352, Blue only#0311140



Model 354 Wool-Blend Blanket

Ì Lightweight 70% wool 30% synthetic fibers

Ì Dry cleaning preferred or machine wash, air dry

Ì Fire retardant to CS 191-53

Ì Measures 1524 x 2032 mm (60 x 80 in.)

Model 354, Charcoal Gray only#0311180



Model 353 Quilted Nylon Blanket

Ì 65% polyester and 35% cotton

Ì Machine wash and dry or dry clean

Ì Measures 1016 x 2286 mm (40 x 90 in.)

Model 353, Red only#0311150



Thermal Mylar Blanket

Ì Efficient insulating material that retains and reflects 90% of body heat

Ì Compact single pack (70 x 125 mm / 2.75 x 5 in.), fits in pocket or bag

Ì Waterproof and weatherproof

Ì Measures 1575 x 2083 mm (62 x 82 in.)

Ì 120 units per box

Thermal Mylar Blanket, 120 Units per Box#0832180



RESQ Pillow

Ì Provides patient comfort for under the head during long carry-outs

Ì Attaches securely to most models of basket stretchers

Ì Lightweight, warm fleece blanket filling can be used to warm patient

Ì Made from durable vinyl, easy to clean

RESQ Pillow#EB700YP

RESQ Blanket Only#EB500B

RESQ Pillow Case Only#EB700YPC



Blanket & Case



Pillow Configuration

Defibrillator Mounts

Increase the safety of your crews and patients during patient transport. An unsecured defibrillator can become a dangerous projectile in an ambulance compartment. Avoid unnecessary risk with a Ferno® defibrillator mount.

- ↳ Easy installation onto a counter top or bench
- ↳ Quick-release mechanism allows easy locking and unlocking of a defibrillator for grab-and-go convenience on scene
- ↳ Swivel base provides easy positioning and viewing of the defibrillator during patient care

200 Defibrillator Mount

Compatible with Physio-Control® Lifepak® 12 or Lifepak 15 with or without bags.

↳ Measures (width, depth, height): 390x305x384 mm (15.375x12x15.125 in.)

Model M-200.....#0822238



M-200

201 Defibrillator Mount

Compatible with Physio-Control® Lifepak® 12 with AC adaptor.

↳ Measures (width, depth, height): 400x305x448 mm (15.75x12x17.625 in.)

Model M-201.....#0822239



M-201

P-300 Defibrillator Mount

Compatible with Phillips® HeartStart MRx defibrillator.

↳ Measures (width, depth, height): 359x365x381 mm (14.125x14.375x15 in.)

Model P-300.....#0822240



P-300

102 Defibrillator Mount

Compatible with Zoll® M Series® defibrillators with Extreme Pack II and NIBP.

↳ Measures (width, depth, height): 264x235x60 mm (10.375x9.25x2.375 in.)

Model Z-102.....#0822242



Z-102

103 Defibrillator Mount

Compatible with Zoll® E Series® defibrillators with soft or hard case

↳ Measures (width, depth, height): 311x311x83 mm (12.25x12.25x3.25 in.)

Model Z-103.....#0822236



Z-103

D360 Swivel Defibrillator Mount

Compatible with Zoll® ProPaq MD and X Series® defibrillators

↳ Measures (width, depth, height): 194x152x38 mm (7.625x6x1.5 in.)

Model D360.....#0822432



D360

Model 175 Cot Fastener with Mounting Kit

Model 175 consists of the antler and rail only. Mounting kits consist of blocks, bracket, hardware, and floor plates necessary to fasten the antler and rail to the mounting bracket and floor plates. The Fastener Kit Complete includes: antler, rail, blocks, hardware, and floor plates.

The following features are included on all models:

- ↳ Wall or floor mounting for rail
- ↳ Permanent and/or detachable mounting for rail and antler
- ↳ Detachable models allow easy floor cleaning
- ↳ Wall-mount models provide maximum aisle space
- ↳ Antler and rail made of aluminum (stainless steel optional)

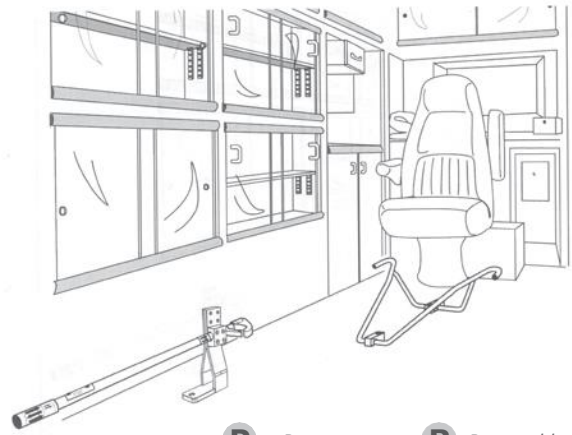

P = Permanent **R** = Removable

Model 175 plus Mounting Kit 175-1

↳ Antler: Permanent Floor Mount

↳ Rail: Permanent Wall Mount

| | |
|--|-----------|
| 175-1 Fastener Kit Complete | #0001751F |
| 175-1 Mount Kit | #0561751 |
| 175 Fastener, rail and antler only | #0567047 |



Model 175 plus Mounting Kit 175-2

↳ Antler: Permanent Floor Mount

↳ Rail: Permanent Floor Mount

| | |
|--|-----------|
| 175-2 Fastener Kit Complete | #0001752F |
| 175-2 Fastener Mount Kit | #0561752 |
| 175-2 Fastener, rail and antler only | #0567047 |



Model 175 plus Mounting Kit 175-3

↳ Antler: Removable Floor Mount

↳ Rail: Removable Floor Mount

| | |
|--|-----------|
| 175-3 Fastener Kit Complete | #0001753F |
| 175-3 Fastener Mount Kit | #0561753 |
| 175-3 Fastener, rail and antler only | #0567047 |



Model 175 plus Mounting Kit 175-4

↳ Antler: Removable Floor Mount

↳ Rail: Removable Floor Mount

↳ Includes an extra set of mounting plates to allow: two different mounting locations (side / center) or setup for two different cot styles

| | |
|--|-----------|
| 175-4 Fastener Kit Complete | #0001754F |
| 175-4 Fastener Mount Kit | #0561754 |
| 175-4 Fastener, rail and antler only | #0567047 |



Model 175 plus Mounting Kit 175-5

↳ Antler: Removable Floor Mount

↳ Rail: Permanent Wall Mount

| | |
|--|-----------|
| 175-5 Fastener Kit Complete | #0001755F |
| 175-5 Fastener Mount Kit | #0561755 |
| 175-5 Fastener, rail and antler only | #0567047 |



Model 5-14 Cot Fastener

- Ì Permanent floor mount for rear fastener handle
- Ì Permanent floor mount for front antler
- Ì Compatible with Model 25 Cot

Model 5-14#0573057

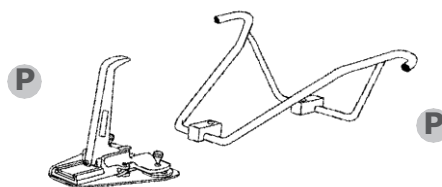

Model 173 Cot Fastener with Mounting Kit 173-2

- Ì Permanent floor mount for front antler and rear hook
- Ì Compatible with Model 28 Chair Cots and Model 28Z

Model 173-2 Fastener Kit Complete#0001732F
 Model 173 Fastener, antler and rear hook only#0567049
 Model 173-2 Mounting Set only#0561731

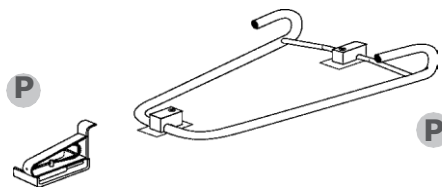

Model 173 Cot Fastener with Mounting Kit 173-3

- Ì Removable floor mount for rear fastener hook
- Ì Removable floor mount for front antler
- Ì Compatible with Model 28 Chair Cots and Model 28Z

Model 173-3 Fastener Kit Complete#0001733F
 Model 173 Fastener, antler and rear hook only#0567049
 Model 173-3 Mounting Set Only#0561732

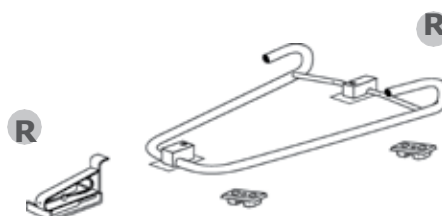

SLAM Series Fasteners

- Ì Easy to unlock transporter from floor of ambulance
- Ì Includes front antler anchorage

SLAM-26

- Ì Compatible with Model 26P Cot

SLAM-26 Contact Ferno Italia

SLAM-26+

- Ì Compatible with Model 26-S Cot

SLAM-26+ Contact Ferno Italia

SLAM-4050

- Ì Compatible with Model 4051/4052 transporters

SLAM-4050 Contact Ferno Italia

SLAM-5026/EFX

- Ì Compatible with Model 5126 and 5226 series cots

SLAM-5026/EFX Contact Ferno Italia

SLAM-26/26+



SLAM-4050/5026

FL1 Fastener

- Ì Single-point latching for reliable operation
- Ì Crash-tested 10G in 5 directions (EN1789 Compliant)
- Ì Guide rails center the cot during the loading process
- Ì Compatible with Mondial® Transporters and Mondial® Monobloc

FL1 Fastener#0573080



Model 185 StatTrac® Fastener

- Ì Heavy-duty track system constructed of aluminum
- Ì Straight-in track design eliminates cot drift
- Ì Can be installed in side or center position inside an ambulance
- Ì Compatible with Model 35 series, 93 series and POWERFlex® Cots

Model 185 StatTrac® Short (2184 mm/86 in.)#0567025
 Model 185 StatTrac® Medium (2438 mm/96 in.)#0567038
 Model 185 StatTrac® Long (2616 mm/103 in.)#0567032



Model 11 Emergency Stretcher with Wheels

↳ Folding 102 mm (4 in.) wheels and posts can be used on the street and then placed directly onto a squad bench equipped with Model 533 Wheel Cups and Models 534/535 Post Cups

↳ Includes two 1524 mm (5 ft.) quick-release patient restraints

↳ Heavy-duty vinyl-coated nylon cover

↳ Can be used with Model 385-A Storage/Carrying Case



| | |
|---|----------|
| Model 11, Burgundy | #0101110 |
| Model 11, Orange | #0101100 |
| Storage Case, Burgundy Unlettered | #0311650 |
| Storage Case, Burgundy Lettered | #0311640 |
| Storage Case, Orange Unlettered | #0311670 |
| Storage Case, Orange Lettered | #0311630 |

CE

Model 11-T Emergency Stretcher with Track

The 11-T has an innovative built-in track system that allows safe evacuation down stairs in the supine position

↳ Sturdy and lightweight with two front wheels for easy maneuvering

↳ Narrow track-to-ground clearance provides easier movement over all surfaces, even with tracks deployed

↳ Heavy-duty vinyl coated cover for ease of cleaning

↳ Folds in half for compact storage

↳ Includes footrest

↳ Locking spring hinge for extra rigidity

↳ Includes two 1524 mm (5 ft.) quick-release patient restraints



| | |
|----------------------------|----------|
| Model 11-T, Burgundy | #0108026 |
|----------------------------|----------|

CE

SPECIFICATIONS

| | Length Unfolded | Length Folded | Width | Height Unfolded | Height Folded | Weight | Load Limit | Shipping Weight | Shipping L,W,H |
|---------------|--------------------|------------------|----------|--------------------|------------------|--------|---------------|--------------------|-------------------|
| 11 Imperial | 74 in. | 37 in. | 19.5 in. | 8 in. | 3.25 in. | 13 lb | 350lb | 18 lb | 38x21x4in. |
| 11 Metric | 1873 mm | 989 mm | 495 mm | 203 mm | 83 mm | 6 kg | 159kg | 8 kg | 965x533x102mm |
| 11-T Imperial | 74 in. | 35 in. | 20 in. | 8 in. | 8 in. | 22 lb | 350lb | | |
| 11-T Metric | 1873 mm | 885 mm | 500 mm | 203 mm | 203 mm | 9.9 kg | 159kg | | |

Model 9 Emergency Stretcher with Backrest and Wheels

- ↳ Telescoping head-end frame section shortens the stretcher
- ↳ Backrest is adjustable to eight angles (0° to 75°)
- ↳ Heavy-duty vinyl coated cover
- ↳ Two 102 mm (4 in.) wheels at head end
- ↳ Stationary posts at foot end
- ↳ Folds in half for compact storage
- ↳ Can be used with Model 385-A Storage/Carrying Case
- ↳ Includes two 1524 mm (5 ft.) quick-release patient restraints

- Model 9, Burgundy.....#0107731
- Model 9, Orange.....#0100900
- Storage Case, Burgundy Lettered.....#0311762
- Storage Case, Orange Lettered.....#0311760



CE

Model 12 Emergency Stretcher

- ↳ Exclusive slimline center hinges enable stretcher to fold for compact storage
- ↳ Heavy-duty vinyl-coated nylon cover
- ↳ Lightweight aluminum frame
- ↳ Can be used with Model 385-A Storage/Carrying Case
- ↳ Includes two 1524 mm (5 ft.) quick-release patient restraints

- Model 12, Burgundy.....#0107742
- Model 12, Orange.....#0101200
- Storage Case, Burgundy Unlettered.....#0311650
- Storage Case, Burgundy Lettered.....#0311640
- Storage Case, Orange Unlettered.....#0311670
- Storage Case, Orange Lettered.....#0311630



CE

Model 12-C Emergency Breakaway Stretcher

- ↳ Stretcher halves separate for easy removal without moving the patient
- ↳ Frame adjusts to align with ambulance-cot backrest, enabling patient to have head elevated during transport
- ↳ Includes two 1524 mm (5 ft.) quick-release patient restraints
- ↳ Heavy-duty vinyl-coated nylon cover

- Model 12-C, Burgundy.....#0107743
- Model 12-C, Orange.....#0107744



CE

SPECIFICATIONS

| | Length Unfolded | Length Folded | Width | Height Unfolded | Height Folded | Weight | Load Limit | Shipping Weight | Shipping L,W, H |
|---------------|-----------------|---------------|--------|-----------------|---------------|--------|------------|-----------------|-----------------|
| 9 Imperial | 74 in. | 38 in. | 19 in. | 6 in. | | 17 lb | 350 lb | 18 lb | 41x20x8in. |
| 9 Metric | 1868 mm | 953 mm | 483 mm | 152 mm | | 8 kg | 159 kg | 8 kg | 1041x508x203mm |
| 12 Imperial | 74 in. | 37 in. | 18 in. | 1 in. | 3 in. | 8 lb | 350 lb | 12 lb | 38x21x4in. |
| 12 Metric | 1873 mm | 940 mm | 464 mm | 29 mm | 60 mm | 4 kg | 159 kg | 5 kg | 965x533x102mm |
| 12-C Imperial | 74 in. | 47 in. | 9 in. | 1 in. | 3 in. | 10 lb | 350 lb | 15 lb | 75x19x2in. |
| 12-C Metric | 1870 mm | 1190 mm | 220 mm | 30 mm | 60 mm | 5 kg | 159 kg | 7 kg | 1905x483x51mm |

Model 107 Stretcher Chair

- ↳ Vinyl-coated nylon cover
- ↳ Folds in half for compact storage
- ↳ High-back chair design
- ↳ Folding foot-end handles provide excellent grip
- ↳ Stationary or hinged 102 mm (4 in.) wheels
- ↳ Folding head-end posts double as lift handles and support legs
- ↳ Legs fold underneath the stretcher for compact storage
- ↳ Foot-end wheels fold flat for storage and snap back into place
- ↳ Fits squad bench post-and-wheel cups for use as a second stretcher
- ↳ Includes two 1524 mm (5 ft.) quick-release patient restraints

Model 107, Burgundy.....#0107714

Model 107, Orange.....#0101070



CE

Model 107-C Stretcher Chair

- ↳ Fixed foot-end posts provide stability when the stretcher is used flat
- ↳ Fixed wheels at both ends permit it to be rolled like a chair or loaded into a specialty ambulance
- ↳ Folding handles at both ends enable it to be used as a standard pole stretcher
- ↳ Includes two 1524 mm (5 ft.) quick-release patient restraints

Model 107-C, Burgundy.....#0107716

Model 107-C, Orange.....#0101072

Storage Case, Lettered, Burgundy 385-F.....#0311762

Storage Case, Lettered, Orange 385-F.....#0311760



CE

SPECIFICATIONS

| | Stretcher Length | Depth Chair | Depth Folded | Width | Height Stretcher | Height Chair | Height Folded | Weight | Load Limit | Shipping Weight | Shipping L,W,H |
|----------------|------------------|-------------|--------------|--------|------------------|--------------|---------------|--------|------------|-----------------|-----------------|
| 107 Imperial | 73 in. | 30 in. | 5 in. | 20 in. | 9 in. | 53 in. | 39 in. | 24 lb | 350 lb | 27 lb | 41x21x6 in. |
| 107 Metric | 1850 mm | 760 mm | 130 mm | 510 mm | 230 mm | 1350 mm | 980 mm | 11 kg | 159 kg | 11 kg | 1041x533x152 mm |
| 107-C Imperial | 82 in. | 26 in. | 6 in. | 20 in. | 6 in. | 54 in. | 40 in. | 25 lb | 350 lb | 30 lb | 41x21x8 in. |
| 107-C Metric | 2080 mm | 650 mm | 160 mm | 500 mm | 140 mm | 1370 mm | 1010 mm | 11 kg | 159 kg | 14 kg | 1041x533x203 mm |

Model 108 Series PoleStretchers

- Ì Heavy-duty aluminum poles for easy handling
- Ì Heavy-duty vinyl-coated nylon covers
- Ì Nonslip hand grips

Model 108 Single-Fold Pole Stretcher

- Ì Simplest Pole Stretcher
- Ì Rolls lengthwise

Model 108, Orange #0101080



Model 108-A Single-Fold PoleStretcher

- Ì Rugged spreader bars and legs provide support
- Ì Folds lengthwise for easy storage
- Ì Available in two lengths and colors

Model 108-A, 81 in. (2057 mm) Orange #0101081

Model 108-A, 90 in. (2286 mm) Orange #0101082



Model 108-AF Double-Fold PoleStretcher

- Ì Folds lengthwise and crosswise for compact storage
- Ì Rugged spreader bars and legs provide support and comfort
- Ì Available in both 2057 mm (81 in.) and 2286 mm (90 in.) lengths

Model 108-AF, 81 in. Orange #0101083

Model 108-AF, 90 in. Orange #0101084

Storage Case for 108-AF-81, Orange, Lettered 383-B #0311470

Storage Case for 108-AF-81, Orange, Unlettered 383-B #0311490



Model 108-F Single Fold-PoleStretcher

- Ì Rugged spreader bars and legs provide support
- Ì Folds lengthwise and rolls for compact storage
- Ì Available in two colors

Model 108-F, Orange # 0101086



SPECIFICATIONS

| | Length | Width | Height | Weight | Load Limit | Shipping Weight | Shipping L, W, H |
|-----------------|--------------|--------|--------|--------|------------|-----------------|------------------|
| 108 Imperial | 84 in. | 22 in. | 2 in. | 8 lb | 350lb | 9 lb | 86x5x3 in. |
| 108 Metric | 2120 mm | 550 mm | 40 mm | 4 kg | 159kg | 4 kg | 2184x127x76 mm |
| 108-A Imperial | 81/90 in. | 22 in. | 6 in. | 12 lb | 350lb | 9/15 lb | 93x7x5 in. |
| 108-A Metric | 2120/2290 mm | 550 mm | 140 mm | 5 kg | 159kg | 5/7 kg | 2360x180x130 mm |
| 108-AF Imperial | 81/90 in. | 22 in. | 6 in. | 12 lb | 350lb | 14/15 lb | 47x8x5 in. |
| 108-AF Metric | 2120/2290 mm | 550 mm | 120 mm | 5 kg | 159kg | 7/7 kg | 1194x203x127 mm |
| 108-F Imperial | 84 in. | 22 in. | 2 in. | 8 lb | 350lb | 10 lb | 44x6x4 in. |
| 108-F Metric | 2120 mm | 560 mm | 40 mm | 4 kg | 159kg | 5 kg | 1118x152x102 mm |

Model 108-D Disaster Litter

The Model 108-D Disaster Litter is an economical, lightweight litter designed for disaster use.

- Ì Ideal for use in situations that require a sturdy, compact, and economical litter for mass-casualty response
- Ì Sturdy aluminum frame
- Ì Easy-to-decontaminate polypropylene mesh cover
- Ì Includes two attached polypropylene restraints
- Ì Folds in half for storage

Model 108-D, Disaster Litter.....#0107969



CE

Model 108-T Tactical Litter

- Ì Designed for tactical, HazMat-CBRN Decon, USAR and disaster use
- Ì Heavy-duty, lightweight poles, hinges, and spreader bars
- Ì Rubber end plugs keep contaminants from penetrating the poles
- Ì Cover is durable, flame retardant, nonslip, chemical- and mildew-resistant polypropylene mesh
- Ì Easy-to-decontaminate
- Ì Fluids flow freely away from patient during decontamination
- Ì Includes two attached polypropylene restraints
- Ì Follows US Military Spec MIL-L-49511B

Ferno® Model 108-T, Olive Drab Green Only.....#0107970



CE

SPECIFICATIONS

| | Length Open | Length Folded | Width Open | Width Folded | Height Open | Height Folded | Weight | Load Limit | Shipping Weight | Shipping L,W,H |
|----------------|----------------|------------------|---------------|-----------------|----------------|------------------|--------|---------------|--------------------|-------------------|
| 108-D Imperial | 90 in. | 45 in. | 22 in. | 9 in. | 6 in. | 4 in. | 13 lb | 350 lb | 15 lb | 47x8x5 in. |
| 108-D Metric | 2290 mm | 1140 mm | 550 mm | 230 mm | 150 mm | 110 mm | 6 kg | 159 kg | 7 kg | 1194x203x127 mm |
| 108-T Imperial | 92 in. | 47 in. | 23 in. | 8 in. | 6 in. | 7 in. | 17 lb | 1200 lb | 22 lb | 49x12x8 in. |
| 108-T Metric | 2340 mm | 1180 mm | 570 mm | 190 mm | 140 mm | 180 mm | 8 kg | 544 kg | 10 kg | 125x305x203 mm |

Model 132 Manta™ Transfer Sheet

- ↳ Folds like a blanket for compact and easy storage
- ↳ Can be used to transfer bariatric patients, evacuate patients, or cover patients during extrication
- ↳ Ideal for rescue from confined areas
- ↳ Pockets at both ends hold backboard, patient's feet and head
- ↳ Fire retardant with holes at each end to allow water drainage
- ↳ Weight capacity: 363 kg (800 lb)
- ↳ Dimensions: 1160 x 1980 mm (46 x 78 in.)
- ↳ Available in burgundy, orange, or olive drab green



- Model 132 Manta, Orange#0382888
- Model 132 Manta, Burgundy#0382969
- Model 132 Manta, Olive Drab Green#0383034



Model 135 Stretcher/Body Bag

- ↳ Folds compactly and completely conceals the body
- ↳ Six durable, permanently-blocked, formed handles
- ↳ Water-repellent top closes with a sturdy slide fastener
- ↳ Two-ply, vinyl-coated nylon construction
- ↳ Resists stains and does not absorb moisture or bodily fluids
- ↳ Flameresistant



- Model 135 Stretcher/Body Bag, Burgundy#0310180



SPECIFICATIONS

| | Length Open | Length Folded | Width Open | Width Folded | Height Folded | Weight | Load Limit | Shipping Weight | Shipping L,W, H |
|--------------|----------------|------------------|---------------|-----------------|------------------|--------|---------------|--------------------|-----------------------|
| 132 Imperial | 79 in. | 12 in. | 46 in. | 9 in. | 3 in. | 5 lb | 800 lb | 7 lb | 17x11x7in. |
| 132 Metric | 2000 mm | 305 mm | 1070 mm | 230 mm | 75 mm | 2 kg | 363 kg | 3 kg | 430x280x180mm |
| 135 Imperial | 77 in. | | 27 in. | | | 17 lb | 500 lb | 22 lb | 91x6x5in. |
| 135 Metric | 1960 mm | | 690 mm | | | 8 kg | 227 kg | 10 kg | 2310x150x130mm |

POWERFlex® + Powered Cot

- Ì 318 kg (700 lb) lifting capacity raises the patient weight without lift assistance
- Ì Complete bariatric solution with load frame handlebar, 454 kg (1000 lb) load capacity in the lowest position and optional LBS Bariatric Board
- Ì All-metal, X-Frame construction provides strength, long service life, and exceptional performance with heavy patients
- Ì Locked-on mattress provides easy patient transfer and security during roadside or aeromedical response
- Ì Bed height range from 330 to 1041 mm (13 to 41 in.) with infinite range of adjustment
- Ì Five-position, folding load frame and adjustable foot-end lift bar
- Ì Optional ICS® Integrated Charging System provides in-the-fastener charging
- Ì US Voltage 110, International Voltage 220 (specify charger voltage when ordering)

| | |
|-------------------------------------|----------|
| PowerFlex+, Red, CE Marked | #0054214 |
| PowerFlex+, Blue, CE Marked | #0054216 |
| PowerFlex+, Red, CE Marked with ICS | #0054215 |
| ICS Kit (Shallow Cup) | #0000600 |
| Charger (US) | #0822426 |
| Charger (UK) | #0822427 |
| Charger (Europe) | #0822428 |
| Charger (Australia) | #0822429 |
| Battery | #0822220 |



See page 22-23 for additional details



Harrier® LT-LBS

- Ì Lightweight trolley, from 69 kg (152 lb)
- Ì Includes extending sides for carrying larger-mass patients
- Ì Excellent maneuverability, combining optimal low-friction wheels with ergonomic operator push-poles (optional accessory)
- Ì Powered up/down lift operation, with slow start-stop movement, for complete patient comfort & operator safety
- Ì Load capacity of 350 kg (772 lb) in raised position, 400 kg (882 lb) when in lowered position
- Ì Simplified high-performance battery management. Uses a detachable rechargeable 28V 3A Milwaukee battery, 77 lifts from 1 single charge, recharge time of less than 1 hour
- Ì IPC compliant, incorporating anti-microbial paint finish, use of Silver Biosafe harness restraints and an easy-to-clean 2-section, Anti-Bacterial Pressure-Relief mattress
- Ì Reflective strips on top, base and X-frame rails, for increased visibility at night
- Ì Compatible with Ferno Two Part Locking System

| | |
|--|--------------|
| Harrier LT-LBS, 2-Part Lock, AB-PR Mattress with AB-Velcro fixing, Biosafe Harness, Long Cotsides & Vertical Poles | #H1E2-H-1-9D |
| Harrier LT-LBS, NMI Lock, AB-PR Mattress with AB-Velcro fixing, Biosafe Harness, Long Cotsides & Vertical Poles | #H1E2-H-3-9D |
| 2-Section AB-PR Mattress w/ Standard Sidearms | #038288350 |
| 2-Section AB-PR Mattress w/ Inflatable Sidearms & Pump | #038288450 |



See page 32 for additional details



SPECIFICATIONS

| | Length Min | Length Max | Width | Height Max | Weight | Load Limit Load Pos. | Load Limit Lowest Pos. | Shipping Weight | Shipping L,W, H |
|-----------------------------|---------------|---------------|--------|---------------|---------|-------------------------|---------------------------|--------------------|-----------------------|
| POWERFlex Imper. 61 in. | | 83 in. | 24 in. | 41 in. | 133 lb | 700 lb | 1000 lb | 230 lb | 87x29x27 in. |
| POWERFlex Met. 1549 mm | | 2108 mm | 610 mm | 1041 mm | 60 kg | 318 kg | 454 kg | 104 kg | 2210x737x686 mm |
| Harrier LT-LBS Imp. 40 in. | | 84 in. | 22 in. | 42 in. | 140 lb | 772 lb | | | |
| Harrier LT-LBS Met. 1020 mm | | 2130 mm | 570 mm | 1055 mm | 63.5 kg | 350 kg | | | |



Features 5-Position Lift Bar and Handles

Extended Seat Panel is 175 mm (6½ in.)
Wider than the Standard 59TEZ Glide

EZ Glide® LBS Bariatric Stair Chair

The EZ Glide® LBS combines all the industry-leading benefits of the EZ Glide tracked chair, but with an extended seat and strengthened chair frame for transferring bariatric patients downstairs.

- ↳ 59T EZ Glide track chair with extended sides, and modified frame
- ↳ Wider seat panel (595 mm / 23 in.) provides more comfort to bariatric patients
- ↳ Strengthened, non-folding chair frame
- ↳ Increased load limit of 318 kg (700lb)
- ↳ Adjustable brake for controlling speed downstairs, adjustable also dependant on patient
- ↳ Strengthened, extended foot plate for patient comfort
- ↳ Optional seat cushion available for improved comfort

EZ Glide LBS#073132910

EZ Glide LBS Seat Cushion#031402600

Accessories: Pages 42



CE

SPECIFICATIONS

| | Height Min | Height Max | Width | Depth | Weight | Load Limit |
|----------|---------------|---------------|--------|--------|--------|---------------|
| Imperial | 37 in. | 63 in. | 23 in. | 33 in. | 64lb. | 700lb |
| Metric | 950 mm | 1610 mm | 595 mm | 850 mm | 29kg | 318kg |

FERNO

LBS Series Bariatric Boards

Ferno® LBS (Large Body Surface) Bariatric Boards allow you to adapt standard Ferno cots while on-scene to bariatric cots to safely transfer and transport bariatric patients. The LBS and LBS Junior Bariatric Boards attach quickly and easily to a Ferno cot, and fold for easy storage when not in use. Compatible with Models 35X, 93H and POWERFlex® cots.

(Existing fastening system installations may not allow the LBS to fit inside the ambulance)



LBS Bariatric Board

- ↳ Quickly attaches to the Ferno® 35X, 93H and POWERFlex® ambulance cots
- ↳ Maximum width: 860 mm (33¾ in.)
- ↳ Includes Manta™ Transfer Sheet
- ↳ Includes one set of restraint extenders and mounting blocks

LBS Bariatric Board, for POWERFlex® and 35X#0822057
 LBS Bariatric Board, for 93H#0819991



LBS Junior Bariatric Board

- ↳ Quickly attaches to the Ferno® 35X, 93H and POWERFlex® ambulance cots
- ↳ Features folding "wings" for better maneuverability through doorways
- ↳ Maximum width: 1040 mm (41 in.), Minimum width: 740 mm (29 in.)
- ↳ Includes Manta™ Transfer Sheet
- ↳ Includes one set of restraint extenders and mounting blocks

LBS Junior, for 35X and POWERFlex®#0822184
 LBS Junior, for 93H#0821936



LBS Mattress

- ↳ Provides added patient comfort
- ↳ Folds away for easy storage
- ↳ LBS: 1778 x 914 x 51 mm (571.5 mm wide at head end)
- ↳ LBS Jr.: 1778 x 698.5 x 51 mm (597 mm wide at head end)

LBS Mattress#0314025
 LBS Jr. Mattress#0314050



LBS Carrying Case

- ↳ Provides added convenience when deploying and storing the LBS

Carrying Case for LBS Mattress Only#0822179
 Carrying Case for LBS, Mattress, and Hardware#0822180



Manta™ Transfer Sheet

- ↳ Deploys quickly and folds compactly for storage
- ↳ Provides multiple handholds for moving patients
- ↳ Load limit of 363 kg (800lb)
- ↳ Dimensions: 1160 x 1980 mm (46 x 78 in.)

| | |
|---|----------|
| Manta Transfer Sheet, Orange..... | #0382888 |
| Manta Transfer Sheet, Burgundy..... | #0382969 |
| Manta Transfer Sheet, Olive Drab Green..... | #0383034 |



Bariatric Tow Package

- ↳ Attaches to cot's head-end load frame to allow the cot to be pulled up ramps by a winch
 - ↳ Compatible with Ferno® Model 35X or POWERFlex® ambulance cots
- Bariatric Tow Package.....#0822121**



Bariatric Push-Pull Handles

- ↳ Handles allow operators to walk in an upright position with optimum body mechanics, while pushing or pulling a cot in its lowest, most stable position
- ↳ Quick-release mounting blocks allow fast and easy attachment and removal of handles
- ↳ Compatible with Ferno® Model 35X or POWERFlex® ambulance cots at the head-end or foot-end or with the LBS Junior
- ↳ Kit comes with one handle and mounting hardware
- ↳ Handles available as angled or straight

| | |
|---|----------|
| Angled (head-end or foot-end), for Cot..... | #0822147 |
| Straight (head-end or foot-end), for Cot..... | #0822148 |
| Angled, for LBS Junior..... | #0822112 |
| Straight, for LBS Junior..... | #0822146 |



Angled Handle Attached to Cot

Straight Handle Attached to LBS Jr.

Restraint Extenders

- ↳ Provide additional length to regular length restraints to transport bariatric patients

| | |
|-----------------------------|----------|
| 1 Foot Length (305 mm)..... | #0313942 |
| 2 Foot Length (610 mm)..... | #0313659 |
| 3 Foot Length (914 mm)..... | #0313670 |





Millennia™ Backboards

- Ì Lightweight, foam-filled, ABS plastic construction
- Ì Minimal deflection provides improved patient stabilization
- Ì Wider, longer handholds provide greater control by EMTs
- Ì Compact, tapered design provides better maneuverability in confined spaces
- Ì Sealed construction resists fluids, chemicals, and extreme temperatures
- Ì X-ray translucent and buoyant for water rescue
- Ì Includes speed-clip pins arranged for various strapping configurations
- Ì Special mounting slots for the Ferno® Model 445 Head Immobilizer
- Ì Available in 16 in. (406 mm) and 18 in. (457 mm) widths

| | |
|------------------------------------|----------|
| 18" Millennia Board, White..... | #0107915 |
| 18" Millennia Board, Blue..... | #0107916 |
| 18" Millennia Board, Orange..... | #0107917 |
| 18" Millennia Board, Yellow..... | #0107918 |
| 18" Millennia Board, Burgundy..... | #0107928 |
| 16" Millennia Board, Blue..... | #0107911 |
| 16" Millennia Board, Orange..... | #0107913 |
| 16" Millennia Board, Yellow..... | #0107914 |
| 16" Millennia Board, Burgundy..... | #0107927 |



Backboard Restraints: Page 65

SPECIFICATIONS



| | Length | Width | Height | Weight | Load Limit | Shipping Weight | Shipping L,W,H |
|--------------|---------|--------|--------|--------|------------|-----------------|----------------|
| 16" Imperial | 72 in. | 16 in. | 2 in. | 13 lb | 350 lb | 14 lb | 74x19x3 in. |
| 16" Metric | 1800 mm | 406 mm | 45 mm | 6 kg | 159 kg | 6 kg | 1880x483x76 mm |
| 18" Imperial | 72 in. | 18 in. | 2 in. | 14 lb | 350 lb | 17 lb | 74x19x3 in. |
| 18" Metric | 1800 mm | 457 mm | 45 mm | 6 kg | 159 kg | 8 kg | 1880x483x76 mm |

Model 889P Fiberglass Backboard

- ↳ Advanced composite board constructed using resin transfer molding to provide a strong rigid board with a smooth durable surface
- ↳ Angled sides allow easy hand hold access
- ↳ 14 oversized handles with a curved edge provides a comfortable grip with no hot spots
- ↳ 20 restraint speed clip pins provide optimum placement of restraints
- ↳ Two handholds at the foot and head end provide additional handling options
- ↳ Includes 4 shoulder harness access holes to facilitate ambulance stretcher harness application to the patient and board
- ↳ Unique symmetrical design simplifies use and wedged design end for confined space and vehicle extrication

889P Backboard, No Restraints#BSBF-889P/B

889P Backboard with 3 Velcro Restraints.....#BSBF-889P



AquaBoard

- The Ferno® AquaBoard has been designed and developed in conjunction with the RLSS UK for the rescue of casualties with suspected spinal injuries from swimming pools and leisure centers.
- ↳ Specially designed to allow the board to be submerged and float up and under the patient
 - ↳ Injured patients can be kept on the AquaBoard while X-Rays are taken
 - ↳ Easy to use color-coded strapping system
 - ↳ Adjustable head restraint
 - ↳ Instructions for patient positioning printed on the neoprene back support
 - ↳ Instructional DVD included
 - ↳ Also capable of salt-water rescue

AquaBoard, Yellow only.....IE10309999



SPECIFICATIONS

| | Length | Width | Height | Weight | Load Limit | Shipping Weight | Shipping L,W, H |
|--------------------|---------|----------|----------|---------|------------|-----------------|-----------------|
| 889P Imperial | 70 in. | 16.5 in. | | 17.5 lb | 350lb | | |
| 889P Metric | 1780 mm | 420 mm | | 8 kg | 159kg | | |
| AquaBoard Imperial | 72 in. | 17 in. | 2.75 in. | 17.5 lb | 400lb | 23lb | 78x17x4in. |
| AquaBoard Metric | 1830 mm | 430 mm | 70 mm | 8 kg | 182kg | 10kg | 2010x430x100mm |



NAJO® Backboards

- Ì Lightweight, one-piece, high-density, polyethylene plastic construction with polyurethane foam fill
- Ì Impervious to bodily fluids and bloodborne pathogens
- Ì X-raytranslucent
- Ì All boards are easy to decontaminate
- Ì Buoyant for floating a patient in water
- Ì All NAJO backboards have a limited lifetime warranty under normal use
- Ì Length may vary +/- 38 mm (1.5 in.) due to shrinking of the material in the manufacturing process



NAJO® RediHold®

- Ì Two hand holds at tapered end provide stable transport
- Ì Head area is smooth to ensure all head immobilization devices adhere to the board
- Ì Angled edges for log-rolling
- Ì Capable of floating 62 kg / 136 lb

16"

| | Yellow | Orange | Green | Red |
|--------|------------|------------|------------|------------|
| No Pin | #275101105 | #275101108 | #275101106 | #275101104 |
| 10 Pin | #275101205 | #275101208 | #275101206 | #275101204 |
| 18 Pin | #275101305 | #275101308 | n/a | #275101304 |



CE

NAJO® RediWide®

- Ì 457 mm (18 in.) wide for rescuers who need "more backboard"
- Ì 45 mm (1.75 in.) thick with angled edges for smooth log-rolls and painless patient placement
- Ì Rectangular shape allows patient placement in either direction
- Ì Capable of floating 78 kg / 172 lb

18"

| | Yellow | Orange | Green | Red |
|--------|------------|------------|------------|------------|
| No Pin | #275301105 | #275301108 | #275301106 | #275301104 |
| 10 Pin | #275301205 | #275301208 | #275301206 | #275301204 |
| 18 Pin | #275301305 | #275301308 | n/a | #275301304 |



CE

SPECIFICATIONS

| | Length* | Width | Height | Weight | Load Limit | Shipping Weight | Shipping L,W,H |
|-------------------|---------|--------|----------|--------|------------|-----------------|----------------|
| RediHold Imperial | 72 in. | 16 in. | 1.75 in. | 16 lb | 600 lb | 20 lb | 73x18x2 in. |
| RediHold Metric | 1829 mm | 406 mm | 45 mm | 7 kg | 272 kg | 9 kg | 1854x457x51 mm |
| RediWide Imperial | 72 in. | 18 in. | 1.75 in. | 16 lb | 600 lb | 20 lb | 73x18x2 in. |
| RediWide Metric | 1829 mm | 457 mm | 45 mm | 7 kg | 272 kg | 9 kg | 1854x457x51 mm |

*Length may vary +/- 38 mm (1.5 in.) due to shrinking of the material in the manufacturing process

NAJO® Lite Board

- ↳ Lightest NAJO series backboard
- ↳ Two handholds at the tapered end provide more stable transport
- ↳ Angled edges for log-rolling
- ↳ Central slot in the lower half of board for immobilizing a patient's legs independently
- ↳ Capable of floating 69 kg / 154 lb

16"



| | Yellow | Orange | Green | Red |
|--------|------------|------------|------------|------------|
| No Pin | #275201105 | #275201108 | #275201106 | #275201104 |
| 10 Pin | #275201205 | #275201208 | #275201206 | #275201204 |
| 18 Pin | #275201305 | #275201308 | #275201306 | #275201304 |

CE

NAJO® Sports Board

- ↳ Specially designed for athletes
- ↳ Large size allows athletes to be immobilized with athletic equipment still on
- ↳ X-raytranslucent
- ↳ Capable of floating 163 kg / 360 lb

20"



| | Yellow | Orange | Green | Red |
|--------|------------|------------|------------|------------|
| No Pin | #275801105 | #275801108 | #275801106 | #275801104 |
| 10 Pin | #275801205 | #275801208 | #275801206 | #275801204 |
| 18 Pin | n/a | #275801308 | #275801306 | #275801304 |

CE

SPECIFICATIONS

| | Length* | Width | Height | Weight | Load Limit | Shipping Weight | Shipping L,W,H |
|-----------------------|---------|--------|----------|---------|------------|-----------------|----------------|
| Lite Board Imperial | 72 in. | 16 in. | 1.75 in. | 14.5 lb | 450 lb | 20 lb | 73x18x2in. |
| Lite Board Metric | 1829 mm | 406 mm | 45 mm | 6.6 kg | 204 kg | 9 kg | 1854x457x51mm |
| Sports Board Imperial | 80 in. | 20 in. | 2.25 in. | 27 lb | 1000 lb | 35 lb | 83x23x3in. |
| Sports Board Metric | 2029 mm | 508 mm | 57 mm | 12 kg | 454 kg | 16 kg | 2110x580x80mm |

*Length may vary +/- 38 mm (1.5 in.) due to shrinking of the material in the manufacturing process



Scoop EXLTM Stretcher

Ferno's Scoop EXLTM Stretcher provides superior comfort and safety to patients who require spinal immobilization. The Scoop EXL eliminates the need for log-roll maneuvers, significantly decreasing movement of the cervical spine.

- ↳ Uncouples at both ends of the stretcher to gently scoop up the patient, or uncouple only one end to use a scissor-type closing motion
- ↳ Oval profile and angled handles provide ergonomic ease of use
- ↳ Twin Safety Lock[®] mechanism provides smooth locking and unlocking
- ↳ Head section is recessed for proper cervical alignment
- ↳ Easy-to clean surface is impervious to fluids
- ↳ X-raytranslucent
- ↳ Folded length is 1194 mm (47 in.) for compact storage
- ↳ Available with or without pins



- 1 **Thermally-treated Polymer Construction** does not get too hot or cold, keeping the patient more comfortable.
- 2 **Adjustable Length** accommodates patients of multiple heights.
- 3 **Narrow Foot-end Frame** improves handling in confined areas.
- 4 **Optional Speed-Clip Pins** allow fast attachment or rearrangement of restraints.

Twin Safety Lock® Mechanism at each end allows either or both ends to separate.



| | #00065EXLMB | #00065EXL7 | #00065EXL | #00065EXLSPCLP | #00065EXLSPCLP |
|-------------------|-------------|------------|-------------|----------------|----------------|
| Restraint | Model 430 | Model 430 | Model 430-P | Model 436 | Model 436 |
| Color | Black | Black | Black | Black | Black |
| Buckle | Metal | Metal | Plastic | Metal | Plastic |
| Length | 1524 mm | 2134 mm | 1524 mm | 1524 mm | 1524 mm |
| # Pieces | 2 | 1 | 2 | 2 | 2 |
| Speed-Clip | No | No | No | Yes | Yes |

Model 561 Scoop™ Wall Bracket#0819876

SPECIFICATIONS

| | Length | Length | Length | Width | Depth | Depth | Weight | Load | Shipping | Shipping |
|----------|---------|---------|---------|--------|-------|--------|--------|--------|----------|----------------|
| | Max | Min | Folded | | Open | Folded | | Limit | Weight | L,W,H |
| Imperial | 79 in. | 65 in. | 47 in. | 17 in. | 3 in. | 3 in. | 18 lb | 350 lb | 22 lb | 67x18x3 in. |
| Metric | 2007 mm | 1650 mm | 1193 mm | 432 mm | 70 mm | 80 mm | 8 kg | 159 kg | 10 kg | 1702x457x76 mm |



Model 65 Scoop™ Stretcher

- ↳ Uncouples at both ends of the stretcher to gently scoop up the patient, or uncouple only one end to use a scissor-type closing motion
- ↳ Supports patient in the position found, reducing risk of further injury
- ↳ Narrow foot-end frame improves handling in confined areas
- ↳ Telescoping tubes provide adjustable length for patients of various heights
- ↳ Folds for compact storage
- ↳ Can be used with Model 385-C Storage/Carrying Case (#0311700)
- ↳ Lightweight, easy to carry

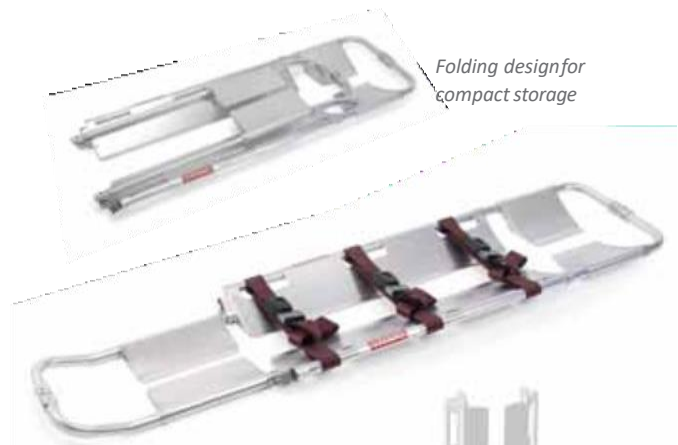

Folding design for compact storage

- Model 561 Scoop™ Wall Bracket#0819876
- Model 65 Scoop™ Mount Bracket#0832259

CEN CERTIFIED Mount Bracket easily secures the Scoop™ in an ambulance for storage



| | #0000452 | #0000451 | #0000450 | #0000449 | #0000448 | #0000447 | #0000325 |
|-------------------|-----------|-----------|-----------|-------------|-------------|-------------|-----------|
| Restraint | Model 430 | Model 430 | Model 430 | Model 430-P | Model 430-P | Model 430-P | Model 436 |
| Color | Black | Black | Orange | Black | Orange | Black | Black |
| Buckle | Metal | Metal | Metal | Plastic | Plastic | Plastic | Plastic |
| Length | 1524 mm | 2134 mm | 2134 mm | 1524 mm | 2134 mm | 2134 mm | 2134 mm |
| # Pieces | 2 | 1 | 1 | 2 | 1 | 1 | 2 |
| Speed-Clip | No | No | No | No | No | No | Yes |

Model 60 Aluminum Backboards

- ↳ Sturdy sheet aluminum is permanently fastened to a tubular aluminum frame forming a lightweight backboard
- ↳ Multiple restraint and handhold openings enable easy handling and various restraint configurations
- ↳ Folds in half to store in a variety of ambulance compartments
- ↳ Includes three nine-foot nylon patient restraints with quick-release metal buckles
- ↳ Available with three full-width runners mounted permanently to the underside of the backboard for convenient handling grip
- ↳ Additional restraint openings allow greater flexibility in restraint configurations for using cravats to immobilize the patient

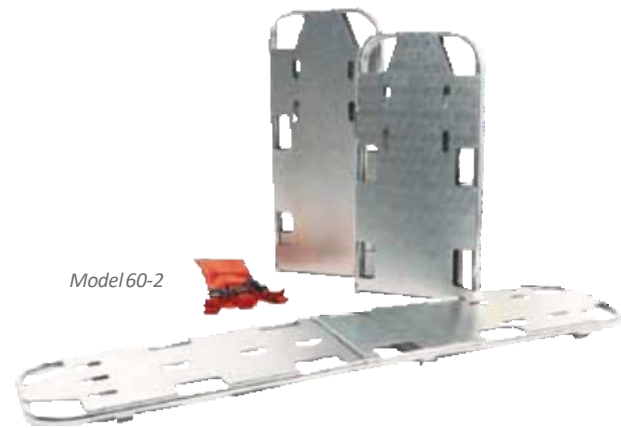

Model 60-2

- Model 60 with restraints#0106000
- Model 60-2 with runners and restraints#0106020
- Model 60-4 with runners and restraints#0106040

SPECIFICATIONS

| | Length Max | Length Min | Length Folded | Width | Depth Open | Depth Folded | Weight | Load Limit | Shipping Weight | Shipping L,W,H |
|---------------|---------------|---------------|------------------|--------|---------------|-----------------|---------|---------------|--------------------|-------------------|
| 65 Imperial | 79 in. | 65 in. | 47 in. | 17 in. | 3 in. | 4 in. | 16 lb | 350 lb | 26lb | 67x18x3in. |
| 65 Metric | 2000 mm | 1650 mm | 1194 mm | 432 mm | 76 mm | 102 mm | 7 kg | 159 kg | 12kg | 1702x457x76mm |
| 60 Imperial | 71.25 in. | | 36 in. | 18 in. | 1.5 in. | 2.5 in. | 17.5 lb | 350 lb | 22lb | 38x21x4in. |
| 60 Metric | 1810 mm | | 914 mm | 457 mm | 38 mm | 64 mm | 8 kg | 159 kg | 10kg | 965x533x102mm |
| 60-2 Imperial | 72.25 in. | | 36 in. | 18 in. | 2.25 in. | 2.5 in. | 14 lb | 350 lb | 22lb | 38x21x4in. |
| 60-2 Metric | 1835 mm | | 914 mm | 457 mm | 57 mm | 64 mm | 6 kg | 159 kg | 10kg | 965x533x102mm |
| 60-4 Imperial | 78 in. | | 39 in. | 18 in. | 2.25 in. | 2.5 in. | 15 lb | 350 lb | 23lb | 46x19x4in. |
| 60-4 Metric | 1981 mm | | 991 mm | 457 mm | 57 mm | 64 mm | 7 kg | 159 kg | 10kg | 1168x483x102mm |



Model 430-P Restraints

- ↳ One- or two-piece, restraint made of 51 mm (2 in.) polypropylene webbing
- ↳ Side-release, snap-lock, plastic buckle tolerates aquatic situations without water damage
- ↳ Squeezable outer prongs allow secure fastening and easy release

| Two-Piece | Black | Orange |
|---------------|----------|----------|
| 1524 mm (5ft) | #0313797 | #0313917 |
| 2134 mm (7ft) | #0313801 | #0313919 |

| One-Piece | Black | Orange |
|---------------|----------|----------|
| 2134 mm (7ft) | #0313894 | #0314011 |



CE

Model 436 Swivel Speed-Clip Restraints

- ↳ Two-piece restraint made of 51 mm (2 in.) nylon-polyester webbing
- ↳ Available with quick-release, automotive-type, coated metal buckle or with a side-release, snap-lock, plastic buckle
- ↳ Swivel speed-clips for quick attachment to backboard with pins
- ↳ Backboard strap kits available with set of four restraints and bag
- ↳ Available in black only

| | |
|--|----------|
| Model 436i, 1524 mm, Metal Buckle..... | #0314122 |
| Model 436i, 2134 mm, Metal Buckle..... | #0314123 |
| Model 436i, 1524 mm, Plastic Buckle..... | #0314124 |
| Model 436i, 2134 mm, Plastic Buckle..... | #0314125 |

Backboard Strap Kits

| | |
|--|----------|
| Model 436, 1524 mm, Metal Buckle, Set of 4 with Bag..... | #0314118 |
| Model 436, 2134 mm, Metal Buckle, Set of 4 with Bag..... | #0314119 |
| Model 436, 1524 mm, Plastic Buckle, Set of 4 with Bag..... | #0314120 |
| Model 436, 2134 mm, Plastic Buckle, Set of 4 with Bag..... | #0314121 |



CE

Model 770 Fastrap™ Restraints

- ↳ Ten-point, six-strap system used to secure patients to backboards
- ↳ Color coded for fast and easy application
- ↳ Nylon with hook-and-loop closures
- ↳ Size adjustable from pediatric to adult
- ↳ Compatible with the Millennia™ Backboard, NAJO® Backboard series, 65 Scoop™ and Scoop EXL™ Stretchers

| | |
|------------------------|----------|
| Model 770 Fastrap..... | #0313916 |
|------------------------|----------|



CE

Model 445 Universal Head Immobilizer

- Ì Composed of two plastic-coated, closed-cell foam head supports, one universal attachment base and two durable head straps
- Ì Head supports can be used on standard backboards, or turned around for use on the Scoop™ Stretcher
- Ì Head strap is designed to conform to the patient's forehead
- Ì Large side openings for monitoring the patient's ear canal
- Ì Minimal interference with X-ray, MRI, or CT scan procedures
- Ì Waterproof coating makes it easy to clean and prevents bacterial growth within components
- Ì Will not absorb blood or bodily fluids and is easy to sanitize
- Ì Compatible with Scoop™ stretchers and Ferno backboards (except NAJO® Sports Board)
- Ì Meets FMVSS 302 flammability rating

Model 445 Universal Head Immobilizer#0313855



CE

CHI - Combi Head Immobilizer

- Ì Uniquely designed base-pad and strapping system provide optimum fitting on all backboards and Scoop™ stretchers
- Ì Fully infection control compliant, using antimicrobial Velcro and PU molded head blocks that contain antibacterial additives throughout
- Ì Accidental surface damage to head blocks does not affect integrity of product and can still be reused, unlike dipped or disposable head blocks
- Ì Compact in design and can be stored while on a backboard or separately in a cabinet
- Ì Modular design allows replacement of individual parts
- Ì X-ray translucent and MRI compatible
- Ì Easy to apply

CHI - Combi Head Immobilizer#031271300



CE

Model 365-E Head Immobilizer

- Ì The Ferno® Head Immobilizer 365-E provides all the great features of the Universal Head Immobilizer with a unique shape specifically designed to fit the Ferno® Scoop EXL™.

Model 365-E#0314044



CE

Model 455 HeadHugger® Head Immobilizer

- Ì Low-cost solution for effective head immobilization
- Ì Heavy-duty, water-resistant corrugated plastic
- Ì Independent support panels fold around the patient's head and are held in place with hook-and-loop fasteners
- Ì Does not interfere with CT scanners or MRIs
- Ì Ideal for use in mass-casualty incidents
- Ì Easy access to monitor blood loss or fluid drainage
- Ì Dual head supports can be molded to fit the contour of each patient
- Ì Single-use head immobilizers, sold in sets of 10



Model 455 HeadHugger, Set of 10#0832092

CE

Model 449 WizLoc® Cervical Collar

- Ì The WizLoc® cervical collar fits 90% of all patients
- Ì Unique self-centering mandibular support allows custom fit to the patient
- Ì Designed for use on patients 2 years old through adult
- Ì On-patient sizing for greater accuracy
- Ì Three-position occipital support with keyhole lockpin
- Ì Can be decontaminated and reused up to 10 times
- Ì High-visibility colors for safety and identification
- Ì X-ray translucent and MRI compatible



Military WizLoc, sold individually#0819759

WizLoc Cervical Collar, set of 3#0822074

KED® PRO

- Ì Designed for extrication /extraction from confined spaces using rope-rescue techniques
- Ì Features metal buckles on leg straps and lateral straps for secure restraint
- Ì One-piece leg strap runs through the spine of the KED PRO and forms a continuous loop for connection to ropes and carabiners
- Ì Two lower and one upper rear-carrying handle rated for vertical and confined space rescue
- Ì Handles help the operator manage the patient during extrication from a vehicle
- Ì Split chest flap provides easy release of top strap to expose chest for examination or possible chest decompression
- Ì Wide head support flaps with shortening ability
- Ì Deceleration shoulder strap assists in proper positioning and prevents movement of the patient within the KED PRO in the event of vehicle deceleration



CE

KED PRO#0314063
 KED Lifting Bridle#BRB-KED

Model 125 KED®

- Ì Proven means of immobilizing and extricating patients from auto accidents or confined spaces
- Ì The wrap-around design provides vertical rigidity for maximum support when immobilizing the spine, neck, and head during extrication, minimizing the risk of further injury
- Ì X-raytranslucent
- Ì Heavy-duty, vinyl-coated nylon is durable and easy to clean
- Ì Case is enlarged to accommodate extrication collars
- Ì Built-in handles enable rescuers to get a firm grip on the patient and KED® as one unit
- Ì Adapts to a hip and pelvic splint by simple inversion
- Ì Adjustable fold-back sides permit easy access to patient's chest
- Ì Adapts for multiple patient sizes, including children and pregnant women



CE

Model 125 KED#0313676

KED® SLED

- Ì Designed to enable a one-on-one retrieval of a patient in a KED-type device by allowing the patient to be easily dragged
- Ì Ideal for confined spaces
- Ì Constructed of durable plastic that the protects the patient and KED

KED SLEDContact Ferno Australia



SPECIFICATIONS

| | Length Open | Length Rolled | Width Open | Width Rolled | Thickness Open | Thickness Rolled | Weight | Load Limit | Shipping Weight | Shipping L,W,H |
|--------------|----------------|------------------|---------------|-----------------|-------------------|---------------------|--------|---------------|--------------------|-------------------|
| KED Imperial | 33 in. | 35 in. | 32 in. | 11 in. | 1 in. | 6 in. | 8 lb | 500 lb | 8 lb | 34x10x5in. |
| KED Metric | 830 mm | 890 mm | 800 mm | 280 mm | 30 mm | 152 mm | 3.5 kg | 227 kg | 4 kg | 864x254x127 mm |
| KED PRO Imp. | 33 in. | 33 in. | 32 in. | 10 in. | 1 in. | 8 in. | 10 lb | 550 lb | | |
| KED PRO Met. | 830 mm | 840 mm | 820 mm | 245 mm | 35 mm | 200 mm | 4.5 kg | 250 kg | | |

SPED - Spinal Protection Extrication Device

- ↳ Low friction material provides easier application between patient and seat
- ↳ Color-coded strapping system deploys from within so it does not disadvantage the user with loose straps and buckles
- ↳ Vacuum splint technology makes the device rigid and molds to the patient within seconds
- ↳ Integral spinal stiffening ribs gives maximum support during procedures
- ↳ Integrated head immobilization helps reduce the risk of unnecessary extrication injury and further trauma
- ↳ Seven lifting handles provide more points of access for better lifting maneuverability

Order from Ferno UK
Tel: +44 (0) 1274851999
Website: www.ferno.co.uk



Ferno® XT

- ↳ The Ferno XT is a revolutionary utility board designed for rapid extrication and spinal immobilization in confined-space areas and critical situations. It can accommodate a wide range of patients and clinical protocols, including pediatric, special needs, bariatric, and pregnant women.
- ↳ Fast extrication: less than 20 seconds with simplified application procedure
- ↳ Easy application with four high-visibility color-coded restraints and buckles, QHI Quick Head Immobilizer, and a smooth surface that slips behind the patient
- ↳ Maximum safety with total patient spinal immobilization
- ↳ Convenient extrication with four carrying handles
- ↳ Lightweight composite fiber board
- ↳ 100% x-ray translucent
- ↳ Easy to decontaminate

Kit XT Complete #0108035



Kit XT Complete

QHI Quick Head Immobilizer



SPECIFICATIONS

| | Length Open | Length Rolled | Width Open | Width Rolled | Thickness | Weight | Load Limit | Shipping Weight | Shipping L,W,H |
|---------------|----------------|------------------|---------------|-----------------|-----------|--------|---------------|--------------------|-------------------|
| SPED Imperial | 39 in. | 28 in. | 26 in. | 10 in. | | 6 lb | 441 lb | | |
| SPED Metric | 1000 mm | 700 mm | 670 mm | 250 mm | | 2.8kg | 200 kg | | |
| XT Imperial | 33 in. | | 12 in. | | .25 in. | 4 lb | 350 lb | 9 lb | 35x15x6in. |
| XT Metric | 830 mm | | 300 mm | | 6 mm | 2 kg | 160 kg | 4 kg | 890x390x140 mm |

Model 441, 443, 444 FernoTrac™ Traction Splints

- Ì Provide in-line mechanical traction
- Ì Relieves pain and reduces the possibility of further vascular and nerve damage
- Ì Simple, adjustable, wrap-around ankle hitch designed to allow medics to check pedal pulses
- Ì Low-profile ischial pad permits splint to be applied with minimum movement of the patient's leg
- Ì Heel stand folds flat for storage and instantly locks into place for support of the injured leg

- Model 444 Adult Traction Splint with case #0822182
- Model 443 Pediatric Traction Splint with case #0822181
- Model 441 Combination 443 plus 444 with case #0822183
- Model 441-1 Combination Carrying Case Only #0314046



CE

Model 663 Air Splint Kit

- Ì Simultaneously splint and stop superficial bleeding
- Ì Inflates with simple air pressure
- Ì X-raytranslucent
- Ì Can be used on children by resizing half-leg or full-leg splints
- Ì Zippers allow quick application
- Ì Kit includes one each of the following splints: hand/wrist, half-arm, full-arm, foot/ankle, half leg, full-leg, and carry case



- Air Splint Kit with carry case, set of 6 splints #SP7645
- Splints also available individually
- Hand-and-Wrist Splint #SP7700
- Half-Arm Splint #SP7701
- Full-Arm Splint #SP7702
- Foot-and-Ankle Splint #SP7703
- Half-Leg Splint #SP7704
- Full-Leg Splint #SP7705



CE

SPECIFICATIONS

| | Length Min | Length Max | Width | Height Min | Height Max | Weight | Shipping Weight | Shipping L,W,H |
|--------------|---------------|---------------|--------|---------------|---------------|--------|--------------------|-------------------|
| 443 Imperial | 31 in. | 46 in. | 8 in. | 2 in. | 8 in. | 3 lb | 8lb | 40x12x5 in. |
| 443 Metric | 790 mm | 1170 mm | 200 mm | 50 mm | 200 mm | 1 kg | 4kg | 1016x305x127 mm |
| 444 Imperial | 35 in. | 54 in. | 9 in. | 3 in. | 9 in. | 5 lb | 8lb | 40x12x5 in. |
| 444 Metric | 890 mm | 1370 mm | 230 mm | 80 mm | 230 mm | 2 kg | 4kg | 1016x305x127 mm |

Ferno® Frac-Care Kit

- Ì Universal, durable, and versatile
- Ì Limb splints can be used as lefts or rights
- Ì X-ray translucent and MRI compatible
- Ì Not recommended for femur fractures where traction is indicated
- Ì Kit includes: adult arm splint, adult leg splint, arm/shoulder immobilizer, child arm splint, child leg splint, extrication collar with neck pad, and waterproof nylon carry case

Ferno® Frac-Care Kit.....#SP9606



Prosplints®

- Ì Universal design allows use on either left or right limbs
- Ì Made of Minicel® foam, a nonabsorbent material
- Ì Blood and bodily fluids can be easily removed
- Ì Conforms quickly to injured area
- Ì Hook-and-loop fasteners make application quick and easy
- Ì Unaffected by severe temperature and weather conditions
- Ì X-ray translucent and MRI compatible
- Ì Kit includes: combo splint (hinged elbow), small leg splint, large leg splint, small arm splint, large arm splint, wrist/forearm splint (adult) and carrying case

Prosplint® Complete kit, blue, with case.....#SP3908

Splints also available individually

Combo Splint (hinged elbow), blue.....#SP3910

Large Leg Splint, blue.....#SP3934



Model 192 Full-Body Vacuum Mattress

- ↳ Conforms to any body shape to fully immobilize the patient
- ↳ Three patient restraints with buckles provide maximum patient security
- ↳ Six carry handles allow the vacuum mattress to be used as a stretcher
- ↳ Includes removable, contoured pillow and compact vacuum pump

| | |
|---|----------|
| Model 192 Full Body Vacuum Mattress, Orange | #0374865 |
| Carry Case | #0374878 |
| Foot Pump | #0832181 |



Foot Pump

CE

Germa EasyFix Vacuum Mattress

The EasyFix Vacuum Mattress features a new body shape design to optimize the vacuum mattress capabilities. Folds easily and requires 20% less storage space than the Germa All-In-One Vacuum Mattresses. EasyFix's unique construction delivers improved immobilization of the upper back, neck and head by a reinforced base plate that covers all of the cervical spine. This together with the x-designed restraint system supports the patient and creates the most effective immobilization.

- ↳ Reinforced base plate covers the head, neck and upper back for improved immobilization of the cervical spine
- ↳ One-piece back support is X-ray translucent
- ↳ New chamber technology allows for quick and easy preparation and ensures the granulate is evenly dispersed for optimal immobilization
- ↳ 10 reinforced carry handles with ergonomic grip
- ↳ Compliant to EN 1789 and 1865
- ↳ Carry capacity of 250 kg (551lb)
- ↳ Lightweight and fold easily for compact storage
- ↳ Available as Ready2GoKit including: Full body mattress + five-color-coded restraints + repair kit + aluminum vacuum foot pump + bag

| | |
|--|-----------------|
| EasyFix Vacuum Mattress | #271 501 000 |
| 2080x1300/720x45 mm / 82x51/28x2 in. (8 kg / 18lb) | |
| Ready to Go Kit / EasyFIX | #271 501 001 |
| Foot Pump | #0832181 |
| Belt Set - 5 Colors (Fix Lock) | #144 018 100 01 |



Foot Pump

CE

Germa Transfer Mattress/ Safe Transfer Mattress

Germa Safe Transfer Mattresses have several additional features compared to a traditional stretcher mattress.

- ↳ Bottom has gliding surface for easy transfer of patient from the stretcher to a hospital bed
- ↳ Six carry handles per side to lift a patient onto the stretcher
- ↳ Carry capacity is 250 kg (551 lb)
- ↳ Evacuation mattress in cooperation with Step by Step equipment
- ↳ Germa Transfer Mattress compliant to European standard EN 1865
- ↳ Safe Transfer Mattress compliant to EN 1865 and EN 1789

Stretcher/Transfer Mattress 12 #271 008000
1950x500x60 mm / 77x20x2 in. (5.3 kg / 12lb)

Stretcher/Transfer Mattress 16 #271 022000
2100x500x60 mm / 83x20x2 in. (5.8 kg / 13lb)

Safe Transfer Mattress #271 029000
1900x500x60 mm / 75x20x2 in. (5.4 kg / 12lb)

Quick-Release Belt Set #23271000714

Velcro Belt Set #23271000713



CE

Germa Easy Comfort Mattress

Easy Transfer Mattress is developed in cooperation with our customers while focusing on ergonomics, patient safety and comfort, together with additional values of patient handling. Easy Transfer Mattress has been tested together with trauma teams for secure efficient handling plus quick and easy transfer of patients and heavy patients.

- ↳ Easy to adjust safety belts
- ↳ Extra comfort 62 mm V-foam supports patient's body weight and delivers a safe and comfortable feeling
- ↳ Easy to lift, carry or slide patient just on the mattress with 10 strong handles
- ↳ The head section lowers for upper airway management
- ↳ Designed to fit on top of Mondial stretchers
- ↳ PVC- Polyester fibre flame retardant
- ↳ Hygienic full welded vinyl is easy to clean with most common disinfectants
- ↳ Sliding material under the mattress, easy to slide patient over to a hospital bed
- ↳ Fits together with Germa Step by Step Carry Kit
- ↳ Length: 1850x500x60 mm (73x20x2 in.), Weight: 5 kg (11lb)
- ↳ Carry capacity is 250 kg (551 lb)
- ↳ Compliant to EN 1865 and EN 1789

Germa Easy Comfort Mattress #21271030000



CE

Model AS190 Vacuum Splint Extremity Kit

Ì Ideal for dislocated shoulders, suspected fractures of arms, legs, and joints, or infant immobilization

Ì Kit includes three splints (small, medium, and large), compact vacuum pump, repair kit and carrying case

Model AS190 Complete Extremity Kit, orange.....#0374861

Splints also available individually

Model AS100 Short arm (small) Orange.....#0374862

Model AS120 Long arm (medium) Orange.....#0374863

Model AS140 Leg (large) Orange.....#0374864

Replacement Vacuum Pump.....#0831965

Carry Case Only, for Model 190.....#0382916



CE

Germa EasyFix Vacuum Splints

The Germa EasyFix Vacuum Splints are intended to stabilize injured patients during transport. They are suited for patients with hand, wrist, arm, leg, shoulder and/or hip injuries. The splint molds around the individual fracture giving an optimal and comfortable support.

Ì Quick and easy to use with unique inner bag with channel system, ensuring granulates are evenly dispersed

Ì PVC coated fabric with robust weldings is easy to clean and disinfect

Ì Velcro® is sewn onto a piece of PVC coated fabric to reinforce the strength of the Velcrostraps

Ì Full leg splint is provided with additional Velcro® straps to ensure one size fits all

Ì Full leg splint can be used as a vacuum mattress for infants and children using the additional Velcro® strap

Full Leg Splint.....#272 101 000

Leg Splint.....#272 102 000

Arm Splint.....#272 103 000

Splint Set I: Arm, Leg, Pump, Bag and Repair Kit.....#272 104 000

Splint Set II: Arm, Leg, Full Leg, Pump, Bag, Repair Kit.....#272 105 000

Vacuum Pump.....#272 000 701



CE

Padded Board Splints

Ì Complete set of six heavy-duty padded-board splints, two of each size: 381, 914, and 1372 mm (15, 36 and 54 in.)

Ì Manufactured of plywood covered with foam padding

Ì Vinyl covering is sealed for easy cleaning and disinfecting

Ì Carry bag included

Padded Board Splint Set.....#SP1872



SAM® Splints (Structural Aluminum Malleable)

- Ì Made of thin strips of soft aluminum and closed-cell foam material
- Ì When folded into a “structural bend” the splint becomes quite rigid and easily supports the leg, forearm, or humerus
- Ì Coating does not stain and is reusable with proper cleaning
- Ì Suitable for splinting legs, arms, wrists, fingers, ankles
- Ì Perfect for infants to adults
- Ì X-raytranslucent
- Ì Can be cut with a pair of trauma shears
- Ì Light and small enough to pack in first aid kit or take on field trips
- Ì Available sizes: Rolled in 914 mm x 108 mm / 36 in. x 4¼ in.
Flat 457 mm x 108 mm / 18 in. x 4¼ in.
Flat 229 mm x 108 mm / 9 in. x 4¼ in.



- 914 mm (36 in.), Rolled, Orange/Blue #SP1121
- 914 mm (36 in.), Rolled, Blue/Gray #SP1122
- 457 mm (18 in.), Flat, Orange/Blue #SP1410
- 229 mm (9 in.), Flat, Orange/Blue, set of 10 #SP1005
- Finger Splint, Orange/Blue, 30 sets of 10 per box #SP1213



CE

SAM® Pelvic Sling™ II

The SAM® Pelvic Sling™ II is for stabilization of pelvic fractures with the correct force. Its new one-piece design is easy to use in just three basic steps. It is still the only force-controlled circumferential pelvic belt scientifically proven in peer-reviewed studies to safely and effectively reduce and stabilize open-book pelvic ring fractures.

- Sam Sling Small (686-1194 mm / 27-47 in.) #0832063
- Sam Sling Standard (813-1270 mm / 32-50 in.) #0832062
- Sam Sling Large (914-1524 mm / 36-60 in.) #0832061



CE

Ferno® Finger Splint Kit

- Ì Contains a variety of the most commonly used splints
- Ì Manufactured from soft aluminum which makes them X-ray translucent and ensures ease of application
- Ì Splints are malleable and can easily be formed to fit each patient
- Ì Kit contains five different splints in a variety of sizes for a total of 25 splints

- Finger Splint Kit, set of 25 #SP9701



CE

Model 672 CPR Board

- Ì Provides a firm surface for CPR training and CPR administration
- Ì Helps to properly position a patient to ensure a constant, open airway
- Ì Head cup maintains proper alignment of patient's head
- Ì Contoured sides make lifting the patient easier
- Ì Measures 591x437 mm (23¼x17¼ in.) and 2 kg (4½lb)

- CPR Board #0831820



CE

Model 678 Pedi-Mate®

- ↳ Designed to adapt an ambulance cot to securely hold a child from 4.5 to 18.1 kg (10 to 40lb)
- ↳ Uses three restraint straps that attach to most Ferno cots
- ↳ Fully-adjustable, five-point harness system fits children firmly, and provides safe restraint during transport
- ↳ Rolls up compactly for efficient storage and retrieval
- ↳ Made from nontoxic, easy-to-clean vinyl



Neo-Mate®

- ↳ Designed for infants weighing 3.2-6.4 kg (7-14lb)

Model 678 Pedi-Mate#0313778

Neo-Mate#0314116



Neo-Mate



Model 678



Baby Pod II

The Baby Pod II is designed to safely transport infant patients to or from a medical facility, between facilities, or between departments within a single medical facility. The Baby Pod II is made from a lightweight carbon fiber outer shell, lined with a shock-absorbent foam inner layer, and transparent shields for viewing the infant. The Baby Pod II contains a patient-positioning vacuum mattress, stretcher fixing straps to secure the device for transport, and safety straps to secure the infant inside the device. Mattress pump is included.



Baby Pod II#0063119



SPECIFICATIONS

| | Length | Width | Height | Length Folded | Width Folded | Height Folded | Weight | Load Capacity |
|-----------------|-----------|--------|--------|------------------|-----------------|------------------|--------|------------------|
| 678 Imperial | 31.25 in. | 19 in. | | 19 in. | 4½ in. | | 2.4 lb | 10-40 lb |
| 678 Metric | 794 mm | 483 mm | | 483 mm | 114 mm | | 1 kg | 4.5-18.1 kg |
| Baby Pod Imper. | 39 in. | 17 in. | 12 in. | | | | 21 lb | 4.4-17.6 lb |
| Baby Pod Metric | 1000 mm | 430 mm | 300 mm | | | | 9.5 kg | 2-8 kg |

G

MEDkids® Pediatric System

Maintain cervical neutral alignment in neonates, infants and children with the self-contained Pneumatic Positioning Device (PPD). Accommodates the wide range of thoracic-elevation requirements without extra padding. Features a palm-style pump with an air-release valve for precise inflation and deflation. Offers versatile strap configurations with its adjustable three-point harness system. Made of durable Dupont® Cordura®. The MEDkids® Baby Board and Pedi-Sleeve are X-ray translucent.

Model 676 MEDkids® Baby Board

- Ì The MEDkids® Baby Board is designed to maintain cervical neutral alignment for pre-term neonates and larger infants ranging from 0.9 to 6.4 kg (2 to 15lb)
- Ì Crescent-shaped head blocks secure cervical spine in infants too small for standard size cervical collars
- Ì Versatile strap configurations with adjustable three-point harness
- Ì Unique design accommodates all central lines, umbilical lines, chest tubes, urinary catheters and other invasive and non-invasive equipment
- Ì Compatible with most EMS cots and isolettes to provide safe and secure transport

Model 676 MEDkids Baby Board#0313922

Model 677 MEDkids® Pedi-Sleeve

- Ì The MEDkids® Pedi-Sleeve is designed to fit over standard adult backboards and provide cervical neutral alignment for infants and children ranging from 5 to 27 kg (12 to 60 lb)
- Ì Crescent shaped compressible head blocks allow access and visual monitoring of the ears while maintaining immobilization
- Ì Versatile strap configurations with the adjustable three-point harness
- Ì Rolls into self-contained carrying case to store in ambulance compartments, drawers, or under bench seats

Model 677 MEDkids Pedi-Sleeve#0313923



CE

Model 78 Pedi-Pac®

- Ì Designed for spinal immobilization of children from 711-1372 mm (28-54 in.) tall, weighing 9-41 kg (20-90 lb)
- Ì Built-in fastening loops connect to existing cot straps for safety during transport.
- Ì Individual leg restraints allow one leg to be immobilized while EMT attends to other leg
- Ì Adjustable head support with ear openings for monitoring fluid drainage
- Ì Sewn-in lifting handles at both ends for easy handling in confined areas
- Ì Replaceable color-coded straps provide fast, easy identification
- Ì Unit comes complete with head and chin straps and carrying case

Model 78 Pedi-Pac#0313065



CE

SPECIFICATIONS

| | Length | Width | Height | Weight | Load Capacity | Shipping Weight | Shipping L,W, H |
|--------------|---------|--------|--------|--------|---------------|-----------------|-----------------|
| 676 Imperial | 23 in. | 11 in. | 1 in. | 6 lb | 2-15 lb | 8 lb | 24x12x10in. |
| 676 Metric | 580 mm | 280 mm | 30 mm | 2.5 kg | 0.9-6.4 kg | 4 kg | 610x300x250mm |
| 677 Imperial | 40 in. | 20 in. | 1 in. | 3 lb | 12-60lb | 5 lb | 24x12x10in. |
| 677 Metric | 1010 mm | 500 mm | 25 mm | 1.5 kg | 5-27 kg | 2 kg | 610x300x250mm |
| 78 Imperial | 48 in. | 9 in. | 1 in. | 7 lb | 90 lb | 10 lb | 49x10x4in. |
| 78 Metric | 1220 mm | 230 mm | 30 mm | 3 kg | 41 kg | 5 kg | 1245x254x102mm |

Model 35-IT Incubator Transporter

- Ì Incubator transporter based on the Model 35A Cot
- Ì Safely secures in Model 175 Cot Fastening System
- Ì Make and model of incubator required for quotes and ordering
- Ì No fold-down load frame feature

Order from Ferno Aviation
 Tel: 770-521-1005
 Website: www.fernoaviation.com



Model 35-ITA Incubator Transporter - Draeger

- Ì Based on the Model 35A Cot
- Ì Fold-down drop frame, made specifically for Draeger incubators
- Ì Safely secures in Model 175 Cot Fastener

Model 35-ITA#0063091

Model 93-IT Incubator Transporter

- Ì Incubator transporter based on the Model 93-ES Cot
- Ì Safely secures in the Model 175 Cot Fastening System
- Ì Make and model of incubator required for quotes and ordering

Order from Ferno Aviation
 Tel: 770-521-1005
 Website: www.fernoaviation.com



Model 28A-IT Incubator Transporter

- Ì Roll-in technology reduces lifting and bending by EMTs
- Ì Safely secures in the Model 173 Cot Fastening System
- Ì Compatible with BK117, BO105, EC135, and EC145 Helicopters
- Ì Make and model of incubator required for quotes and ordering

Model 28-1-IT Incubator Transporter

- Ì Based on the Model 28Z Cot
- Ì Roll-in technology reduces lifting and bending by EMTs
- Ì Make and model of incubator required for quotes and ordering

Order from Ferno Aviation
 Tel: 770-521-1005
 Website: www.fernoaviation.com



SPECIFICATIONS

| | Height Min | Height Max | Height Folded | Length | Width | Weight | Loading Height | Load Limit | Shipping Weight | Shipping L,W,H |
|-----------------|---------------|---------------|------------------|---------|--------|--------|-------------------|---------------|--------------------|-------------------|
| 35-IT Imperial | 9 in. | 40 in. | | 79 in. | 23 in. | 70 lb | 31 in. | 500 lb | 84lb | 84x25x18in. |
| 35-IT Metric | 229 mm | 1003 mm | | 2000 mm | 584 mm | 32 kg | 787 mm | 227 kg | 38 kg | 2110x640x460mm |
| 93-IT Imperial | 18 in. | 38 in. | 9 in. | 81 in. | 21 in. | 74 lb | 33 in. | 500 lb | 94lb | 84x25x20in. |
| 93-IT Metric | 457 mm | 965 mm | 229 mm | 2057 mm | 533 mm | 34 kg | 838mm | 227 kg | 43 kg | 2130x640x510mm |
| 28A-IT Imperial | | 33 in. | 8 in. | 78 in. | 24 in. | 60 lb | 26 in. | 400 lb | 87lb | 80x25x13in. |
| 28A-IT Metric | | 838 mm | 204 mm | 1980 mm | 610 mm | 27 kg | 650 mm | 181 kg | 44 kg | 2030x640x330mm |

POWERFlexx®-IT Incubator Transporter

- Ì Incubator transporter based on the POWERFlexx® Cot
- Ì 700 lb load capacity
- Ì Available with fold-down load frame
- Ì Safely secures in Model 175 Cot Fastening System
- Ì Make and model of incubator required for quotes and ordering

Order from Ferno Aviation
 Tel: 770-521-1005
 Website: www.fernoaviation.com



ITC Incubator Transport Interface

- ITC Incubator Transport Interface is specifically designed to carry transport incubators.
- Ì Lightweight, high-quality aluminum frame construction
 - Ì Four handles provide ergonomic ease of use
 - Ì Easy installation onto the cot with six fastener blocks (standard on all units)
 - Ì Four fastener points for interfacing with the incubator
 - Ì Complete flexibility and interchangeability
 - Ì Compatible with Cot Models 26S, 26P, 35A, 35P, 5126, 5126EL, Model 147 Cot Airshields
 - Ì Tested in compliance with EN 1789

Order from Ferno Italia
 Tel: +39 051 6860028
 Website: www.ferno.it



ITU - Incubator Transporter Unit

- Speed and safety are of paramount importance when incubators need to be transported between hospitals. This specially-designed, highly-maneuverable ITU is fully compatible with Ferno Lock+Load to accomplish the task quickly and easily.
- Ì Lightweight for ultimate maneuverability
 - Ì Single push/pull handles at each end
 - Ì Compatible two-part mechanical lock supplied with floor fixings
 - Ì Designed to carry major incubator units

Order from Ferno UK
 Tel: +44 (0) 1274851999
 Website: www.ferno.co.uk



SPECIFICATIONS

| | Height | Length | Width | Width Handles Ext. | Weight | Load Limit |
|--------------|--------|---------|--------|--------------------|--------|------------|
| ITC Imperial | 5 in. | 47 in. | 24 in. | 40.5 in. | 22 lb | 176 lb |
| ITC Metric | 135 mm | 1200 mm | 620 mm | 1030 mm | 10 kg | 80 kg |
| ITU Imperial | 24 in. | 72 in. | 21 in. | | 106 lb | 309 lb |
| ITU Metric | 615 mm | 1830 mm | 545 mm | | 48 kg | 140 kg |

Ferno® Trauma Bags

- Ì Constructed of durable DuPont® Cordura® with dual-density Plastazote® structural foam and YKK® Zippers
- Ì Includes removable stiffeners and inserts for custom configuration
- Ì Replaceable bottom protects the bag from wet ground
- Ì Limited lifetime warranty



Ferno® Model 5103 Trauma Responder II Bag

- Ì Enhanced outside pocket with elastic loops and pouch
- Ì Full-opening top compartment
- Ì Elastic loops, dividers and interior pouch
- Ì Molded feet on bottom for extra protection
- Ì Available in red or blue
- Ì Dimensions (L, W,H) 432x229x394 mm (17x9x15.5 in.)



Ferno® Model 5103, Trauma Responder II Bag

- Red #0819775
- Blue #0819776

Ferno® Model 5107 Professional Trauma Bag

- Ì Nonslip shoulder strap
- Ì Elastic pouches in front pocket keeps supplies organized
- Ì External easy-access top pocket
- Ì Tuck-away backpack harness system
- Ì Compatible with Ferno Mini-Bags
- Ì Available in orange, red, and blue
- Ì Dimensions (L, W,H) 559x305x381 mm (22x12x15 in.)



Ferno® Model 5107 Professional Trauma Bag

- Orange #0819786
- Red #0819787
- Blue #0819788

Ferno® Model 5108 Professional ALS Bag

- Ì Same design as 5107 bag with the addition of 4 Mini-Bags:
- Ì One Medication Mini-Bag 5114
- Ì One Intubation Mini-Bag 5115
- Ì Two Intravenous Mini-Bag 5116
- Ì Available in orange, red, and blue
- Ì Dimensions (L, W,H) 559x305x381 mm (22x12x15 in.)



Ferno® Model 5108 Professional ALS Bag

- Orange #0819789
- Red #0819790
- Blue #0819791

Ferno® Model 5113 First-In Trauma Bag

- ↳ Enhanced front pocket with elastic loops
- ↳ External pocket on lid
- ↳ Compatible with Ferno Mini-Bags
- ↳ Available in orange, red, and blue
- ↳ Dimensions (L, W,H) 381x292x368 mm (15x11.5x14.5 in.)

Ferno® Model 5113 First In TraumaBag

| | |
|-------------|----------|
| Orange..... | #0819808 |
| Red..... | #0819809 |
| Blue..... | #0819810 |



Ferno® Model 5150 Rucksack with Airway Roll

- ↳ Handles fold away into pocket
- ↳ Reflexite® high-visibility strips/reflective webbing
- ↳ Tuck-away backpack harness system
- ↳ Five different-sized clear plastic pouches
- ↳ Rucksack available in green only
- ↳ Airway Roll available in orange only
- ↳ Rucksack Dimensions (L, W,H): 508x356x203 mm (20x14x8 in.)
- ↳ Airway Roll Dimensions (L,W): 495 x 864 mm (19.5x34in.)

| | |
|---|----------|
| Model 5150, Rucksack Bag Only..... | #0819859 |
| Model 5151, Airway Roll Only, Orange..... | #0819860 |
| Model 5150 with Model 5151..... | #0005150 |



Ferno® Model 5148 Luno Bag

- ↳ Reflective strips and webbing
- ↳ Available in orange only
- ↳ Dimensions (L, W,H): 406x267x203 mm (16x10.5x8 in.)

| | |
|----------------------------------|----------|
| Model 5148 Luno Bag, Orange..... | #0819857 |
|----------------------------------|----------|



Ferno® Model 5149 Luno Bag

- ↳ Similar to 5148 Luno Bag with added storage compartments on ends
- ↳ Various storage options for small items on lid
- ↳ Double handles and detachable shoulder strap
- ↳ Large side pockets
- ↳ Removable padded dividers
- ↳ Available in orange only
- ↳ Dimensions (L, W,H): 533x279x203 mm (21x11x8 in.)

| | |
|----------------------------------|----------|
| Model 5149 Luno Bag, Orange..... | #0819858 |
|----------------------------------|----------|



Ferno® Airway Bags

- Ì Constructed of durable DuPont® Cordura® with dual-density Plastazote® structural foam and YKK® Zippers
- Ì Includes removable stiffeners and inserts for custom configuration
- Ì Replaceable bottom protects the bag from wet ground
- Ì Limited lifetime warranty



Emergency Respiratory Care Backpack(ERC)

- Ì Quick-access flap to oxygen regulator
- Ì Hands-free operation with convenient backpack straps
- Ì Carry the ERC like a duffle bag with an extra strap
- Ì Reflective strips for better night visibility
- Ì Five custom hook-and-loop labels to designate compartments
- Ì Holds "Jumbo D" cylinder or Spiracle® "DD"-Lite carbon fiber cylinder
- Ì Available in green only
- Ì Dimensions (L, W,H): 572x305x241 mm (22.5x12x9.5 in.)

ERC Backpack, Green#0819634



Ferno® Model 5110 Trauma/Airway Management Bag II

- Ì Tuck-away backpack harness system
- Ì Access oxygen through end pocket or from main compartment
- Ì Adjustable storage in main compartment
- Ì Compatible with Ferno Mini-Bags
- Ì Available in red, blue, and green
- Ì Dimensions (L, W,H): 584x305x381 mm (23x12x12.5 in.)

Ferno® Model 5110, Trauma/Air Management Bag II

Red#0819797
 Blue#0819798
 Green#0819799
 Replaceable Bottoms#0819865



Ferno® Model 5111 Trauma/Airway Management Bag III

- Ì Removable back pocket for WizLoc™ or cervical collars
- Ì Oxygen access through end pocket or from main compartment
- Ì Front pocket includes pouch and elastic loops for organizing supplies
- Ì Carries "D" and "Jumbo D" size cylinders
- Ì Compatible with Ferno Mini-Bags
- Ì Available in orange, red, blue, and green
- Ì Dimensions (L, W,H): 635x381x318 mm (25x15x12.5 in.)

Ferno® Model 5111, Trauma/Airway Management Bag III

Orange#0819800
 Red#0819801
 Blue#0819802
 Green#0819803
 Replaceable Bottoms#0819864



Ferno® Model 5100 Airway Management / Oxygen Bag

- Ì Oxygen access through outside pocket
- Ì "D" and "Jumbo D" compatible
- Ì Outside pocket organized with pouch and elastic loops
- Ì Includes two 5137 utility pouches, one 5131 pouch, and O2 bag with handle as shown
- Ì Tuck-away backpack harness system
- Ì Compatible with Ferno Mini-Bags
- Ì Available in orange, red, and blue
- Ì Dimensions (L, W, H): 584x241x330 mm (23x9.5x13 in.)

Ferno® Model 5100, Airway Management/Oxygen Bag

| | |
|-------------|----------|
| Orange..... | #0819768 |
| Red..... | #0819769 |
| Blue..... | #0819770 |



Ferno® Model 5120 Oxygen Carry Bag

- Ì Single-piece design carries a "D" size cylinder
- Ì Square aluminum frame prevents it from rolling to one side
- Ì Padded for protection
- Ì Double-zip opening for easy access to regulator
- Ì Integrated hooks allow it to hang from cot
- Ì Available in orange, red, blue, and green
- Ì Dimensions (L, W, H): 559x159x229 mm (22x6.25x9 in.)

Ferno® Model 5120, Oxygen Carry Bag

| | |
|-------------|----------|
| Orange..... | #0819825 |
| Red..... | #0819826 |
| Blue..... | #0819827 |
| Green..... | #0819828 |



Ferno® Model 5121 Oxygen Carry Bag

- Ì Same features as 5120
- Ì Carries an "E" size cylinder
- Ì Available in red and blue
- Ì Dimensions (L, W, H): 851x114x229 mm (33.5x4.5x9 in.)

Ferno® Model 5121, Oxygen Carry Bag

| | |
|-----------|----------|
| Red..... | #0819830 |
| Blue..... | #0819831 |



Ferno® Model 5122 Oxygen Carry Bag

- Ì Same features as 5120
- Ì Carries a "Jumbo D" size cylinder
- Ì Available in blue only
- Ì Dimensions (L, W, H): 851x114x229 mm (33.5x4.5x9 in.)

Ferno® Model 5121, Oxygen Carry Bag, Blue.....#0819835



Ferno® Model 5115 Intubation Mini-Bag

- Ì Displays airway supplies for ease of use
- Ì Removable internal pouch for miscellaneous supplies
- Ì Removable card for additional storage
- Ì Available in orange, red and blue
- Ì Dimensions (L, W,H): 330x76x241 mm (13x3x9.5 in.)

| | |
|--------------------------|----------|
| Model 5115, Orange | #0819814 |
| Model 5115, Red | #0819815 |
| Model 5115, Blue | #0819816 |



Ferno® Model 5116 Intravenous Mini-Bag

- Ì Provides organization for IV supplies
- Ì Billow pocket for small sharps container
- Ì Easily stores away in larger kits
- Ì Available in red and blue
- Ì Dimensions (L,W,H): 229x114x279 mm (9x4.5x11 in.)

| | |
|------------------------|----------|
| Model 5116, Red | #0819818 |
| Model 5116, Blue | #0819819 |



Ferno® Model 5117 Trauma Mini-Bag

- Ì Organizes trauma supplies with elastic loops and mesh pockets
- Ì Durable mesh windows for easy identification of supplies
- Ì Available in red or blue
- Ì Dimensions (L, W,H): 343x76x241 mm (13.5x3x9.5 in.)

| | |
|------------------------|----------|
| Model 5117, Red | #0819821 |
| Model 5117, Blue | #0819822 |



Ferno® Model 5130 Intubation Ultra Mini-Bag

- Ì Holds a variety of emergency airway supplies and accessories
- Ì Fits into any larger bag
- Ì Available in blue only
- Ì Dimensions (L, W,H): 292x140x51 mm (11.5x5.5x2 in.)

| | |
|------------------------|----------|
| Model 5130, Blue | #0819847 |
|------------------------|----------|



Ferno® Model 5114 Medication Mini-Bag

- Ì A modernized approach to organizing drugs
- Ì Compact design for easy storage in any kit
- Ì Eight removable medication cards (four 5118 Ampoule Cards and four 5119 Vial Cards)
- Ì Available in red and blue
- Ì Dimensions (L,W,H): 229x90x216 mm (9x3.5x8.5 in.)

| | |
|------------------------|----------|
| Model 5114, Red | #0819812 |
| Model 5114, Blue | #0819813 |



Ferno® Model 5118 Ampoule Card /5119 Vial Card

- Ì High-density foam
- Ì Contained in special plastic cassette
- Ì Organizes and protects ampoule medications
- Ì Pre-cut foam for easy set up
- Ì Used with model MB-5114 (shown above)
- Ì Available in black only

| | |
|---------------------------------------|----------|
| Model 5118, Ampoule Card, Black | #0819823 |
| Model 5119, Vial Card, Black | #0819824 |



Saver Bags

Saver Bags are lightweight and provide exceptional value with a variety of features such as padded compartments for organizing supplies, large pockets for plenty of storage, heavy-duty zippers and straps, and Dupont® Cordura® nylon construction. They have a limited lifetime warranty.

Saver Model 2100 First Responder Bag

Dimensions (L, W, H): 483x279x203 mm (19x11x8in.)

Saver 2100 First Responder Bag, Red #0819902

Saver 2100 First Responder Bag, Blue #0819895



Saver Model 2102 Trauma Responder Bag II

Dimensions (L, W, H): 500x305x216 mm (19.5x12x8.5in.)

Saver 2102 Trauma Responder Bag II, Red #0819903

Saver 2102 Trauma Responder Bag II, Blue #0819896



Saver Model 2103 Trauma Responder Bag III

Dimensions (L, W, H): 495x394x216 mm (19.5x15.5x8.5in.)

Saver 2103 Trauma Responder Bag III, Red #0819904

Saver 2103 Trauma Responder Bag III, Blue #0819897



Saver Model 2110 O₂ Trauma Kit

Dimensions (L, W, H): 673x406x254 mm (26.5x16x10in.)

Saver 2110 O₂ Trauma Kit, Red #0819905

Saver 2110 O₂ Trauma Kit, Blue #0819898



Saver Model 2120 O₂ Duffel Kit

Dimensions (L, W, H): 686x356x267 mm (27x14x10.5in.)

Saver 2120 O₂ Duffel Kit, Red #0819906

Saver 2120 O₂ Duffel Kit, Blue #0819899



Saver Model 2130 ALS Bag

Dimensions (L, W, H): 559x330x254 mm (22x13x10in.)

Saver 2130 ALS Bag, Red #0819907

Saver 2130 ALS Bag, Blue #0819900



Flambeau® Orange Medical Kits

Flambeau® Medical Kits are highly durable and provide a variety of compartments that are ideal for carrying a wide range of medical supplies. These kits are made from a lightweight, heavy-duty copolymer material that is resistant to rust, dust, scratches, and most common chemicals.

Model 2274

Model 2072

Model 1872



Flambeau® 1702 Medical Box (not shown)#0831902

Dimensions (L, W, H): 419x222x191 mm (16.5x8.75x 7.5in.)

Flambeau® 1872 Medical Box#0831898

Dimensions (L, W, H): 448x260x 222 mm (17.625x10.25x 8.75 in.)

Flambeau® 2072 Medical Box#0831899

Dimensions (L, W, H): 483x264x257 mm (19x10.375x10.125 in.)

Flambeau® 2272 Trauma Box#0831897

Dimensions (L, W, H): 495x292x 298 mm (19.5x11.5x11.75in.)

Plano® 747-M Trauma Box

↳ Features a drop-front panel, three trays that pull out like drawers or which can be accessed from the top like conventional boxes, and a deep box for larger items

↳ Suited for use as either a drug or trauma kit

↳ Built to last with rugged handle, solid brass hardware, ABS latches and durable padlock eyes

↳ Dimensions (L, W, H): 324x517x292 mm (12.75x20.375x11.5 in.)



Plano® 747-M Trauma Box#0831900

Saver First Aid Kits

Saver First Aid Boxes are not a re-badged fishing or toolbox but a purpose-designed medical box for first aid use. Each box comes standard with a locking feature, making the kits tamper-proof if desired.

Each box has an over-center catch and a tongue and groove seal, which provides a tighter seal of the box, making them resistant to dust and water. Another unique feature is the set of removable dividers in the white trays, which allow you to customize each compartment. The trays also have a generous depth for greater storage and a smooth surface for easy cleaning.



Saver First Aid Kit#FAF1672G

Dimensions (L,W,D): 320x185x140 mm (12.5x7.25x5.5in.)

Saver First Aid Kit#FAF1772G

Dimensions (L,W,D): 420x220x185 mm (16.5x8.75x7.25in.)

Saver First Aid Kit#FAF1872G

Dimensions (L,W,D): 450x250x220 mm (17.75x10x8.75in.)

Ferno® Compact First Aid Boxes

The Ferno 1272 and 1472 first aid boxes are compact, lightweight and ideal for hiking, travelling or driving as they provide simple storage of your first aid equipment in the car, caravan or in your backpack. The Ferno® Compact Kits feature a full-length hinge and snap-lock lid that ensures a tight and secure closure.



- Compact First Aid Box.....#FAF1272G
Dimensions (L,W,D): 255x110x40 mm (10x4.375x1.5in.)
- Compact First Aid Box.....#FAF1472G
Dimensions (L,W,D): 355x140x60 mm (14x5.5x2in.)

Pelican™ Equipment Cases

- ↳ Approved for use on airlines and by the U.S. Military
- ↳ Atmospheric purge valve relieves pressure inside the case from altitude changes
- ↳ O-ring gasket provides an airtight, watertight seal
- ↳ Equipment and medical supplies stay safe, dry, and secure
- ↳ Built with an open-cell core and solid-wall construction
- ↳ Extra-thick wall construction makes case nearly crush-proof
- ↳ Stainless steel pins secure handles, hinges, and latches
- ↳ Metal-reinforced padlock protectors and double-throw latches
- ↳ Available in three sizes: medium, large, and extra large
- ↳ Each size is available with either Pick-N-Pluck™ foam or adjustable padded dividers
- ↳ Pick-N-Pluck™ foam allows you to customize your case for your specific needs
- ↳ Cases are available in yellow and orange



- Dimensions (L, W,H)
- Large**
Interior: 477x364x194 mm (18.75x14.375x7.625in.)
Exterior: 524x429x207 mm (20.625x17x8.125 in.)
- Extra Large**
Interior: 550x425x200 mm (21.625x16.75x8in.)
Exterior: 630x495x220 mm (25x19.5x9in.)

- Pick-N-Pluck™ Foam Case, Extra Large, Yellow.....#MB160004
- Padded Dividers Case, Large, Yellow.....#MB155404
- Padded Dividers Case, Extra Large, Orange.....#MB160400



Pick N Pluck Foam



Padded Dividers

ORO₂ Oxygen Regulators

- ↳ Strong uni-constructed body
- ↳ CGA 870 pin index connection
- ↳ 0-3,000 psig Gauge
- ↳ Fixed-orifice flow control with window-style flow reading
- ↳ Flow specifications range from 0-25 lpm
- ↳ Settings of ¼, ½, 1, 2, 3, 4, 6, 8, 10, 15, and 25
- ↳ Regulator provides a gas-regulated pressure of 57 psig at 2000 psi
- ↳ Flow accuracy of plus or minus 10% of reading
- ↳ "C"-ring clamp aids in retaining the tee-handle
- ↳ Five year warranty and a voucher for a free spare replacement gauge
- ↳ Available in CGA 870 and 540 configuration



Model 816-Aluminum Body, Brass Component

ORO₂ Oxygen Regulator, 0-25 lpm, 12-position flow control with barbed outlet and two DISS outlets with safety check valves, low profile, booted gauge.

Model 816-Aluminum Body, Brass Component#0819740



Model 817-Aluminum Body, Brass Component

ORO₂ Oxygen Regulator, same as Model 816, except with international 0-4000 psi booted pressure gauge.

Model 817-Aluminum Body, Brass Component#0819741



Model 818-Aluminum Body, Brass Component

ORO₂ Oxygen Regulator, 0-25 lpm, 12-position flow control with barbed outlet only, low profile, booted gauge.

Model 818-Aluminum Body, Brass Component#0819742



Model 818D-Aluminum Body, Brass Component

ORO₂ Oxygen Regulator, same as Model 818, except with a 12-position flow control with DISS outlet only.

Model 818D (not shown) Call for Specifications

Model 819-Aluminum Body, Brass Component

ORO₂ Oxygen Regulator, same as model 818, except with international 0-4000 psi booted pressure gauge.

Model 819-Aluminum Body, Brass Component#0819744



Model 804-Aluminum Body, Brass Component

ORO₂ Oxygen Regulator, CGA 540 DISS inlet for "H" and "M" size cylinders, one DISS 40 to 60 psi outlet with safety check valve UL listed 0-4000 psi pressure gauge with boot.

Model 804-Aluminum Body, Brass Component#0819567



BRAVO₂ Brass Oxygen Regulators

- ↳ Strong uni-constructed body
- ↳ CGA 870 pin index connection
- ↳ 0-3,000 psig Gauge
- ↳ Fixed-orifice flow control with window-style flow reading
- ↳ Flow specifications range from 0-25 lpm
- ↳ Settings of ¼, ½, 1, 2, 3, 4, 6, 8, 10, 15, and 25
- ↳ Regulator provides a gas regulated pressure of 57 psig at 2000psi
- ↳ Flow accuracy of plus or minus 10% of reading
- ↳ "C"-ring clamp aids in retaining the tee-handle
- ↳ Five year warranty and a voucher for a free spare replacement gauge
- ↳ Available in CGA 870 and 540 configuration*

*Minimum quantity required/special order



Model 830-Brass Oxygen Regulator

BRAVO₂ Oxygen Regulator, 0-25 lpm, 12-position flow control with barbed outlet and two DISS outlets with safety check valves, low profile, booted gauge.

Model 830#0819965



Model 831-Brass Oxygen Regulator

BRAVO₂ Oxygen Regulator, same as Model 830, except with international 0-4000 psi booted pressure gauge.

Model 831#0819746



Model 832-Brass Oxygen Regulator

BRAVO₂ Oxygen Regulator, 0-25 lpm, 12-position flow control with barbed outlet only, low profile, booted gauge.

Model 832#0819966



Model 833-Brass Oxygen Regulator

BRAVO₂ Oxygen Regulator, same as Model 832, except with international 0-4000 psi booted pressure gauge.

Model 833#0819748



ORO₂ Flow Control Valves

- ↳ 12-position flow control settings ranging from the OFF position to ¼, ½, 1, 2, 3, 4, 6, 8, 10, 15, and 25lpm
- ↳ Accuracy of plus or minus 10% to reading
- ↳ The brass, nickel-plated DISS outlet allows precise connection using standard DISS or BARB connections
- ↳ Accommodates nebulizers, humidifiers, or nipple/nut connectors ¼ and ½ lpm +/- 20%
- ↳ All-metal construction

Model 900 ORO₂ with DISS Male Outlet and BARB Outlet#0819583
 Model 901 ORO₂ with BARB Outlet#0819584



Model 900

Model 901



O₂ E-Class Flowmeter

- ↳ Polycarbonate tube, nickel-plated brass
- ↳ Agion™ knob material, inhibits growth of odor-causing micro-bacteria
- ↳ Precise and adjustable needle valve assembly, for accurate flows
- ↳ Stainless steel ball float and clear scale provide easy to set flow.

E-Class Flowmeter#T21EC15
 E-Class Flowmeter w/ British Quick Connect#T21EC15-B
 E-Class Flowmeter w/ Ohio Diamond Quick Connect#T21EC15-OD



British Quick Connect



Ohio Diamond Quick Connect

Model 903 Micro-Manager Administrator™ (anodized aluminum)

- ↳ Constant flow device of 10 lpm for one to five patients simultaneously
- ↳ Check valves & threaded barbed fittings with flow-restriction orifices
- ↳ Attach to an oxygen regulator capable of delivering 40 to 90 psi
- ↳ Provides a 50 psi outlet to operate a demand valve resuscitator or gas-powered suction device

Micro-Manager with five 10 lpm Orifices#R01000
 Micro-Manager w/ five 6 lpm Orifices and 1829 mm Hose#R01010
 Replacement Packages: Five DISS x Barb lpm fittings
 For 2 lpm, 5 per package Call for Specifications
 For 4 lpm, 5 per package#R06004
 For 6 lpm, 5 per package#R06006
 For 10 lpm, 5 per package#R06010
 For 15 lpm, 5 per package#R06015



Oxygen Supply Hoses Sold Separately



Model 905 Mini-Manager Administrator™ (aluminum alloy)

- ↳ Equipped with five flow-control valves
- ↳ Able to provide flow rates from 0-25 lpm for one to five patients
- ↳ Manifold with DISS Oxygen Inlets
- ↳ Comes in a soft carrying case and stores compactly
- ↳ 60 month warranty

Model 905 Mini-Manager O₂ Administrator™#0819585



Oxygen Supply Hoses Sold Separately



Model 908 Multi-Manager Administrator™ (aluminum)

- ↳ Equipped with eight flow-control valves with standard DISS
- ↳ Able to provide flow rates from 0-25 lpm for one to 8 patients
- ↳ Manifold is mounted on a collapsible aluminum alloy tripod
- ↳ Can be connected with a second unit to treat up to 16 patients
- ↳ Stores compactly and storage case available (Model RO9081)
- ↳ 60 month warranty

Model 908 Multi-Manager O₂ Administrator™#0819586



Oxygen Supply Hoses Sold Separately



Disposable Cuff Mask

Contoured, anatomically-shaped cushion allows gas-tight low-pressure seal. Hypo-allergenic materials. Little or no blow-by during oxygen administration. Available in infant, child, and adult sizes.

- Single-Use Cuffed Mask Size 1, Infant#RB131008
- Single-Use Cuffed Mask Size 3, Child/Small Adult.....#RB131004
- Single-Use Cuffed Mask Size 5, Adult#RB131005



CE

Reusable Silicone Face Masks

- Ì Contoured anatomically-shaped cushion
- Ì Gas-tight low-pressure seal with hypo-allergenic materials
- Ì Little or no blow-by during oxygen administration
- Ì Available in pediatric and adult sizes

- Reusable Face Mask, Size 0, Infant#RB132080
- Reusable Face Mask, Size 1, Infant.....#RB1320081
- Reusable Face Mask, Size 2, Infant/Child.....#RB1325042
- Reusable Face Mask, Size 3, Child.....#RB1330043
- Reusable Face Mask, Size 4, Adult.....#RB1330054
- Reusable Face Mask, Size 5, Adult.....#RB1330055



CE

Model 302 OX-Series Inhalator Valve

- Ì Provides 100% source gas to a breathing patient with minimal respiratory effort
- Ì Compact and lightweight design weighs only three ounces
- Ì Used on spontaneously breathing patients for aquatic injuries, dive accidents, smoke inhalation and carbon monoxide poisoning

- Model 302, Inhalator Valve with Three adaptors#0819656
- Model 302-10, Inhalator, 1829 mm Hose and Adult Mask#0819657
- Model 302, Inhalator/Exhalation Valve Assembly.....#RO5000

Model 302-10



CE

Model 301 HFOC™ Oxygen Conserver

- Ì High-flow oxygen conserver delivers 100% oxygen during resuscitation
- Ì Performs function regardless of resuscitator rate and bag stroke volume
- Ì Operates from any standard 50 psi gaseous oxygen source

- Ì Has an integral back pressure relief diaphragm to relieve pressure greater than atmospheric
- Ì Adaptors to attach the HFOC™ to the most popular brands of bag valve resuscitators provided

Ì Comes with 1829 mm (6 ft) O₂ supply hose

- Model 301-10 for use w/ NPB PMR-II Adult Bag Resuscitators #0819628
- Model 301, w/1829mm Hose for use w/22mm Bag Inlet Port #0819738

Adapters

- 15 mm I.D. x 22 mm O.D. AdapterCall for Specifications
- 23 mm I.D. x 28 mm O.D. AdapterCall for Specifications
- 26 mm I.D. x 31 mm O.D. AdapterCall for Specifications
- Silicon Rubber Adapter (Use with RO3012 Adapter to Connect Bag/Mask Resuscitators with 22 mm Male Inlets)..... Call for Specifications



Three Adaptors Included

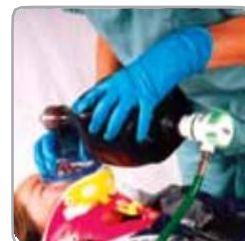

CE

DVRx Demand Valve Resuscitator

- Ì Provides 100% oxygen through a mask, endotracheal tube, esophageal airway or tracheotomy tube to a breathing or nonbreathing patient
- Ì Manual triggered flow: 40 LPM. Spontaneous breathing: 160 LPM

- DVRx Demand Valve Resuscitator#T10560



Single Patient Use BVM with Medication and Monitoring Port

- ↳ Transparent re-breathing valve assembly allows clear viewing of valve
- ↳ Lightly-textured PVC bag for sure grip and comfort
- ↳ Latexfree
- ↳ 360° patient valve swivel connection
- ↳ Adult size will easily collapse for compact storage
- ↳ Comes complete with mask reservoir bag and O₂ tubing
- ↳ Bag Valve Mask Resuscitator can be used in conjunction with FERNO₂ HFOC Model 301 to achieve 100% oxygen delivery
- ↳ 40 cm H₂O pressure-relief valve standard on pediatric/infant models
- ↳ Silicone hand strap included for optional steady grip
- ↳ Medication and Monitoring Port on outlet side of BVM

| | |
|--------------------------------------|---------|
| Single Patient Use BVM, Adult | #T30533 |
| Single Patient Use BVM, Child | #T30532 |
| Single Patient Use BVM, Infant | #T30531 |



CE

Silicone Reusable BVM with Medication and Monitoring Port

- ↳ Silicone material provides excellent bag re-expansion
- ↳ Superior feel of lung compliance helps reduce risk of over-inflation
- ↳ Sized for adult, pediatric (5.5-55 lb.), and infant patient ventilation
- ↳ Integrated intake/oxygen valve for ease of oxygen delivery
- ↳ Easy to disassemble/assemble for efficient cleaning
- ↳ See-through mask with unique multi-function mask cover
- ↳ 40 cm H₂O pressure-relief valve standard on pediatric/infant models
- ↳ BVM's can be used in conjunction with FERNO₂ HFOC Model 301 to achieve 100% oxygen delivery
- ↳ Comes complete with mask reservoir bag and O₂ tubing

| | |
|---------------------------------|---------|
| Adult Complete in Carton | #T30536 |
| Child Complete in Carton | #T30535 |
| Infant Complete in Carton | #T30534 |



CE

CPR Mask

- ↳ Reusable mask used for mouth-to-mask ventilation
 - ↳ Ready to use right out of its rugged storage case
 - ↳ Latex-free
 - ↳ Comes complete with filtered inlet valve, O₂ inlet port and head strap
- | | |
|--|---------|
| FERNO ₂ CPR Pocket Mask | #RO2820 |
|--|---------|



CE

Oxygen Hoses

Green pressure oxygen hose with two female DISS fittings, (compatible with LSP Demand Valve, LSP Aspirator, LSP Minilator and others)

| | |
|--|---------|
| O ₂ Hose with Two Female Fittings, 1.8 m / 6 ft | #RO2600 |
| O ₂ Hose with Two Female Fittings, 6 m / 20ft | #RO2620 |

Green pressure oxygen hose with 1/8" male NPT and one female DISS fitting, (works with FERNO₂ OX Inhalator FERNO₂ HFOC, Elder Demand Valve and LSP Bag Refill Valve)

| | |
|--|---------|
| O ₂ Hose with one male and one female fitting, 1.8 m / 6 ft | #RO2610 |
|--|---------|



Aluminum Oxygen Cylinders

- ↳ Up to 40% lighter than steel
- ↳ Absorb more impact energy
- ↳ Have greater resistance to damage from rough handling or accidental dropping
- ↳ Contaminants can't be trapped on the smooth, rust-free interior surface of aluminum cylinders
- ↳ Folding built-in on/off lever eliminates need for wrench or handwheel
- ↳ Available in "C", "D", Jumbo "D", and "E" sizes

- "C" Size Cylinder (248 liters).....#RO2500
- "D" Size Cylinder (415 liters).....#RO2510
- Jumbo "D" Size Cylinder (637 liters).....#RO2520
- "E" Size Cylinder (682 liters).....#RO2530



Model 205, 206, 210, 211 'DD'-Lite® & 'EE'-Lite® Carbon Fiber O₂ Bottles

Fully wrapped, carbon-fiber reinforced, aluminum-lined vessels manufactured with the highest-grade aerospace materials. Both products carry DOT regulatory certifications for design and qualification certifications. The 'DD'-Lite® and 'EE'-Lite® can be mounted to a Ferno 35A+, 93H, 35X, or 93-EX Squadmate™ cots and can also be mounted to the back of an EMS bicycle. The significant reduction in weight and greater capacity of these carbon-fiber vessels means you can carry more oxygen to remote locations, onboard helicopters, up flights of stairs, and in your ambulance.

| | 'DD'-Lite® | 'EE'-Lite® |
|----------------------|--|-------------------------|
| Service Pressure: | 3000 psi (207 bar) | 2216 psi (153 bar) |
| Volumetric Capacity: | 200" (3.28 liters) | 516" (8.46 liters) |
| Outer Diameter: | 5.83" (137mm) | 6.63" (168 mm) |
| Length: | 13.5" (302mm) | 20.42" (519 mm) |
| Weight: | 3.7 lb. (1.68kg) | 7.3 lb. (3.31 kg) |
| Oxygen Content: | @3000 psi: 717 liters @2000 psi: 533 liters | @2216 psi: 1,377 liters |

- 'DD' Lite Model 205 with CGA 870 Post Valve and On/Off Toggle#0819963
- 'DD' Lite Model 206 with CGA 540 Valve Outlet#RO2060
- 'EE' Lite Model 210 with CGA 870 Post Valve and On/Off Toggle#0819964
- 'EE' Lite Model 211 with CGA 540 Valve Outlet#0819589



Oxygen Vessel Comparisons Chart

| | Steel "D" | Alum. "D" | Jumbo "D" | Alum. "E" | "DD"-Lite | "EE" Lite |
|---------------------------|------------------|-------------------|-------------------|-------------------|-------------------|------------------|
| Oxygen Contents (liters): | 396 | 415 | 637 | 682 | 717 | 1377 |
| Weight | 10.3 lb (5 kg) | 7.9 lb (3.6 kg) | 8.6 lb (4 kg) | 8.0 lb (3.6 kg) | 3.7 lb (1.7 kg) | 7.3 lb (3.3 kg) |
| Diameter | 4.5 in. (114 mm) | 4.37 in. (111 mm) | 5.25 in. (133 mm) | 4.37 in. (111 mm) | 5.3 in. (135 mm) | 6.6 in. (168 mm) |
| Length | 20 in. (208 mm) | 15.5 in. (394 mm) | 7.5 in. (191 mm) | 25.6 in. (650 mm) | 13.5 in. (343 mm) | 20.4 (518 mm) |
| Service Pressure (psi) | 2015 | 2015 | 2216 | 2015 | 3000 | 2216 |

Model 521 Oxygen BottleHolder (Universal Bracket Base)

- ↳ Designed for steel and aluminum cylinders including "D", "E" and Jumbo "D" sizes
- ↳ Will not rust or corrode
- ↳ Universal bracket base adapts to cylinder size
- ↳ Neck support bracket can slide up or down with common tools to secure cylinders
- ↳ Bracket does not interfere with most oxygen regulator controls
- ↳ Heavy-duty nylon strap and metal buckle keep cylinder in place
- ↳ Bracket can be mounted vertically or horizontally

Model 521, Oxygen Bottle Holder.....#0822187



Model 515 and 516 Cylinder Brackets (Floor-Mounted)

- ↳ Securely hold either "D" or "E" size oxygen cylinders in place
- ↳ Floor-mounted base provides secure retention system
- ↳ Eliminates swaying, tipping, and rattling oxygen cylinders

Model 515, Cylinder Base, Single.....#0815150
 Model 516, Cylinder Base, Dual.....#0815160



Model 519 and 520 Bottle Base (Wall-Mounted)

- ↳ Securely hold either "D" or "E" size oxygen cylinders in place
- ↳ Wall-mounted base provides secure retention system
- ↳ Eliminates swaying, tipping, and rattling oxygen cylinders

Model 519, Bottle Base, Single.....#0815190
 Model 520, Bottle Base, Dual.....#0815200



Model 514 Oxy-Clip™

- ↳ Designed to place the oxygen cylinder on the cot sidearm rather than underneath the cot or between the patient's legs
- ↳ Securely holds either steel or aluminum "D" size cylinders
- ↳ Spring-loaded latch enables the Oxy-Clip™ to instantly attach to the cot sidearm (19 mm / 0.75 in. diameter)

Model 514, Oxy-Clip™ for Any Cot (except Model 28).....#0085500
 Model 514-1, Oxy-Clip™ for Model 28.....#0085520



Emergency Respiratory System

- Ì Provides resuscitation, gas-powered suction and oxygen therapy in a lightweight package
- Ì Configured using the ERC (Emergency Respiratory Case)
- Ì Made from 600 Denier Cordura
- Ì Can be carried like a backpack or like a bag
- Ì Shoulder straps and waist belt can be tucked away

System includes:

- Ì ERC Case
- Ì Uni-Body brass regulator (0-25 lpm) with constant flow and two high-flow outlets
- Ì Demand valve with 1.8m/6 ft. hose
- Ì Single patient mask
- Ì Cuffed mask
- Ì Gas powered aspirator one "D" size aluminum oxygen cylinder (415 liters/O₂) or one "EE"-Lite carbon fiber oxygen vessel with a capacity of 1377 liters of oxygen

ERS with "EE"-Lite Carbon Fiber Tank Call for Specifications
 ERC Backpack Only #0819634



SAR Backpack Portable

- Ì Designed for urban search and rescue and remote wilderness rescue
- Ì Has a technical frame back panel, two internal 6063 aluminum stays, contoured shoulder straps, side compression and load lifting straps
- Ì Built for proper distribution of the load
- Ì Integrated nylon rain cover with storage pocket
- Ì Large volume main compartment holds "D", Jumbo "D", or "DD-Lite" cylinder
- Ì First aid cross is reflective for nighttime visibility
- Ì Padded and breathable mesh shoulder straps w/ hydration tube clip

SAR Backpack Only #0819755

Complete SAR Backpack Portable Kit

- Ì "DD-Lite" carbon fiber oxygen vessel with BRAVO2 oxygen regulator
- Ì SAR Backpack Portable Case

Complete SAR Portable Kit #RK3010

Deluxe SAR Backpack Portable Kit

- Ì Complete SAR Backpack Portable Kit
- Ì OX-series Inhalator with oxygen hose
- Ì Adult size Spiracle/MEDS PPV mask

Deluxe SAR Portable Kit #RK3020



Seahorse Portable Airway Kit

- Ì For emergency respiratory care in pre-hospital, marine and industrial settings
- Ì Designed to withstand the harshest of environments with a hard shell Pelican™ case and watertight seal

Kit Includes:

- Ì "DD-Lite" carbon fiber oxygen vessel
- Ì OX Series Inhalator Valve with O₂ supply hose
- Ì BRAVO2 Brass Oxygen Regulator
- Ì Yellow Pelican™ case with custom die cut, closed-cell foam insert, purge valve and collapsible handle

Seahorse Portable Airway Kit Complete #SPA702



Model 425 Intubation Kit

- Ì Carrying case
 - Ì Miller 1, 2, and 4 fiber-optic blades & Mac 2 and 3a fiber-optic blades
 - Ì Handle
 - Ì Blades and handle are ISO Green System compatible
 - Ì Spare bulb (size "C" batteries not included)
- Kit Model 425 #0819593
 Carrying Case Only Call for Specifications



Individual Laryngoscope Blades & Handles

- Ì Stainless steel (SS) fiber-optic blades
 - Ì Blades autoclaveable
 - Ì Blades and handle are ISO Green System compatible
 - Ì Spare bulb (size "C" batteries not included)
- Handle Fiber-Optic Laryngoscope, Pediatric #AM14010999
 Handle Fiber-Optic, Standard #AM14011199



| Blades | Size 0 | Size 1 | Size 2 | Size 3 | Size 4 |
|-----------|-------------|-------------|-------------|-------------|-------------|
| Macintosh | #AM14040000 | #AM14040001 | #AM14040002 | #AM14040003 | #AM14040004 |
| Miller | #AM14050000 | #AM14050001 | #AM14050002 | #AM14050003 | #AM14050004 |

Guedel Emergency Airway Kit

- Ì Combines six disposable, individually numbered Guedel Airways
- Ì Plastic pouch for easy storage and access
- Ì Large lumen offers free exchange of expired air and rescue breaths
- Ì Each airway is contoured for maximum comfort
- Ì Kit includes six sizes: infant (50mm), small child (60mm), child (70mm), small adult (80mm), medium adult (90mm) and adult (100mm)



Guedel Emergency Airway Kit, 6 per box AM21009999

Nasopharyngeal Airways

- Ì Robertazzi style airway with fixed flange
 - Ì Made of neoprene (latex-free) and designed to minimize entry trauma and increase patient comfort
 - Ì For use where patient has a blockage of normal anatomical airway
- Latex-Free Naso Airway Kit of 9 #AM1520



Kit of 9 includes nine sizes along with water-soluble sterile lubricant packs: 20, 22, 24, 26, 28, 30, 32, 34, and 36fr. Also available individually.
 Kit of 6 excludes: 20, 34, and 36fr.

PosiTube Endotracheal Detection Device

- Ì Ideal detection device to differentiate between the patient's trachea and esophagus
- Ì Designed to verify proper placement of the endotracheal tube or double lumen airway

PosiTube Endotracheal Tube Placement Check Device#RO6200



Grip-ET® Endotracheal Tube Holder

- Ì Works with any ET tube from sizes 4.5 to 10 mm
- Ì The patented clip slides into place, locking quickly
- Ì The wide-open base leaves the mouth open for visualizing and suctioning the mouth
- Ì The twist lock pivots hold the clip in for added security
- Ì The hook and loop strap wraps around the head for a quick and easy hold

Grip-ET® with Endotracheal Tube Holder Bite Block#FA0009



MVP Suction Unit

- Ì Robust, lightweight, high-vacuum portable suction unit
- Ì Reusable pistol-style pump
- Ì Comes with disposable 300ml disposable collection jar, 13mm adult and 6mm child disposable suction catheters
- Ì Collection jar rotates for optimal position for suctioning/aspiration
- Ì Designed with an overflow protection mechanism that resists clogging and prevents spilling

MVP Suction Unit, Adult/Child Kit#SU13209999
 Replacement Canister with Large-Bore Catheter#SU13309905



CE

MicroVac Suction Unit

- Ì Lightweight unit designed to be attached to any 50 psi DISS outlet
- Ì Unique, color-coded on/off shuttle provides fast actuation of the unit
- Ì Suction catheter can be quickly and easily cleared by covering the unit's exhaust port with one finger, reversing the flow

MicroVac Powered Suction Unit with Hose#T10561



Wall-Mounted Blood Pressure Cuff

This clock aneroid sphygmomanometer is perfect for ambulances, hospitals or clinics. The mounting bracket offers cuff storage, while enabling the unit to swivel for easy viewing.

- Ì Large easy to read 150 mm (6 in.) dial
- Ì 300mm Hg No Pin Stop Mechanism
- Ì 110 degree rotation for easy viewing
- Ì Nylon Velcro cuff with PVC bladder with nickel-plated air release valve
- Ì 8 foot (when extended) of coil tubing

Wall Mounted Blood Pressure Cuff#T1046019



PEZO2 Pulse Oximeter

- Ì Large OLED display has 10 brightness settings and orientation options
- Ì Hard plastic design protects the unit from rigorous daily use

PEZO2 Pulse Oximeter#T10565



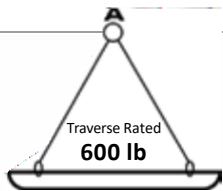

Model 71 Basket Stretcher

- ↳ One-piece basket stretcher
- ↳ High-density polyethylene shell is strong and resistant to chemicals, UV, rust, and corrosion
- ↳ Heavy-duty aluminum frame with molded-in runners and handholds
- ↳ Brass grommets provide fast connection to Model 418-1 Adjustable Lifting Bridle (see page 106)
- ↳ Closed-cell foam pad is easily replaced
- ↳ X-ray translucent for arms, legs, and chest
- ↳ Includes four restraints

- Model 71 Basket Stretcher, One-Piece#0107100
- Model 387-A, Orange Storage Case for Model 71#0311800

Model 71-S Split Basket Stretcher

- ↳ Includes the same great features as the Model 71 basket stretcher
- ↳ Separates in half for backpacking to a rescue site or for compact storage

- Model 71-S Split Stretcher, Two-Piece#0107101
- Model 387-B, Storage Case, Orange, Lettered#0311820
- Model 387-B, Storage Case, Orange, Unlettered#0311830

Model 71-M Non-Metallic Basket Stretcher

One piece, non-metallic version for use in subways and mining areas where electrical hazards or sparks could hamper rescue efforts. Features plastic-coated aluminum frame, plastic rivets, wooden runners, and hook-and-loop restraints.

- Model 71-M Non-Metallic One-Piece Basket Stretcher#0107104

71-S separates in half for compact storage and backpacking to a rescue site.

71-M is non-metallic for use in areas where electrical hazards or sparks could hamper rescue efforts.

Accessories

- 1 Flotation Collar**
#0313943
- 2 Model 513-4 IV Pole**
#0085480
- 3 Model 418-1 Bridle**
#0312390 (Orange Bag)
#0314112 (Black Bag)

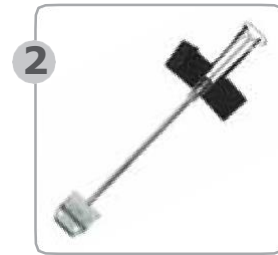

SPECIFICATIONS

| | Length | Width | Depth | Depth | Weight | Load | Shipping | Shipping | Shipping | Shipping L,W,H | Shipping L,W,H |
|----------|---------|--------|---------|--------|--------|--------|----------|----------|----------|----------------|----------------|
| | | | 71/71-S | 71-M | 71 | Limit | Wt. 71 | Wt. 71-M | Wt. 71-S | 71/71-M | 71-S |
| Imperial | 86 in. | 24 in. | 8 in. | 9 in. | 23 lb | 600 lb | 36 lb | 40 lb | 38 lb | 87x24x8 in. | 47x27x11 in. |
| Metric | 2180 mm | 610 mm | 190 mm | 250 mm | 10kg | 272 kg | 16 kg | 18 kg | 17kg | 2210x610x203mm | 1194x686x279mm |



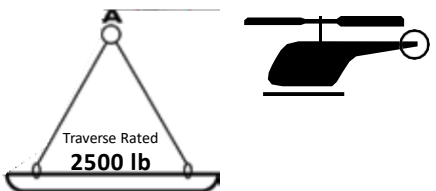

Spartan Split-Apart Basket Stretcher

The fully stainless steel frame has a 2500 lb (1100 kg) strength rating while providing a completely smooth sliding surface on the bottom to handle rough terrain. The outer high density polyethylene (HMWPE) shell is securely attached to the middle rail leaving the top rail completely exposed to provide unencumbered access for multiple rescuers to grab the rail at any location. This eliminates the need for rescuers to find hand cutouts and makes the rail easy to grasp even while wearing thick gloves.

Ï Split-apart feature with LocSafe™ connectors provide fail-safe connection and allows the stretcher to be assembled in about 15 seconds

Ï StratLoad™ attachment points provide secure bridle attachment with any size carabiner

1 Smooth Sliding Surface on the bottom provides better handling over rough terrain.

3 StratLoad™ attachment points provide secure bridle attachment.

2 LocSafe™ connectors provide fail-safe connection.

Spartan Split-Apart Basket Stretcher.....#0108036



CE

SPECIFICATIONS

| | Length | Width | Height | Weight | Shipping Weight | Load Rating |
|----------|---------|----------|---------|--------|-----------------|-------------|
| Imperial | 86 in. | 24.5 in. | 7.5 in. | 35 lb | 41 lb | 2500lb |
| Metric | 2180 mm | 620 mm | 190 mm | 16 kg | 19 kg | 1134kg |

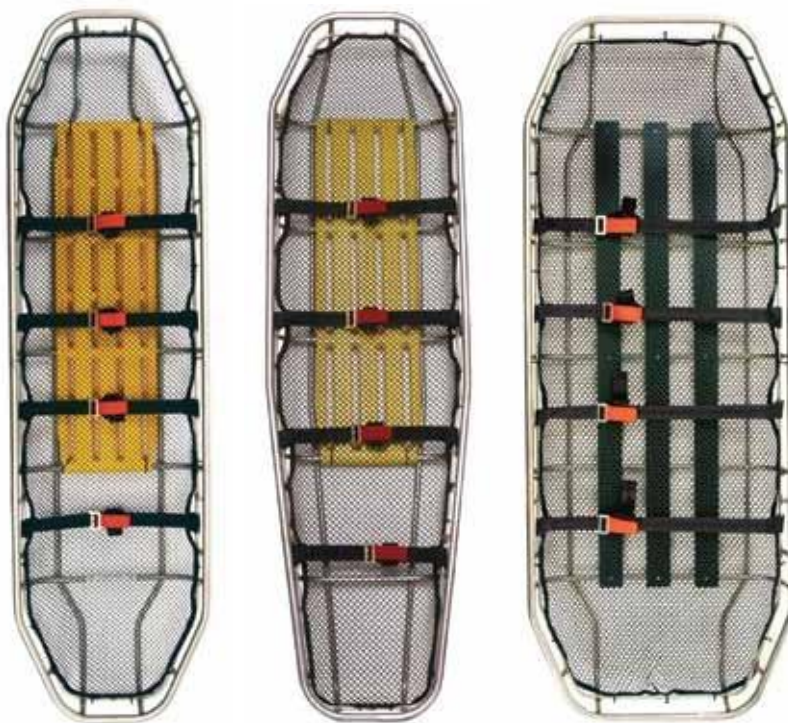

Regular

Tapered

Extra-Wide

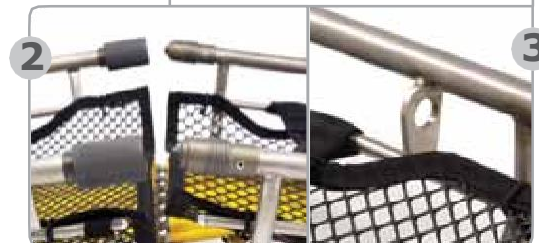
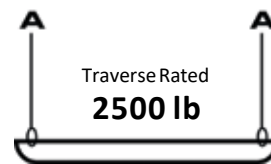

Titan Stainless Steel Basket Stretchers

The Titan Rescue Basket Stretcher is a complete rethinking of the classic Stokes military-style stretcher. The top rail is a full one-inch (25 mm) diameter making the stretcher easier to handle when carried for extended periods. Available in one-piece or two-piece and regular, tapered, or extra-wide models.

- ↳ StratLoad™ attachment points for secure attachment of lifting bridles
- ↳ Designed to surpass the US Military specification MIL-L-37957A
- ↳ One-inch (25 mm) top rail is very easy to hold on to, especially in long carries
- ↳ Replaceable Durathene™ netting replaces the old-style chicken wire
- ↳ UHMW-PE Back Support- no more splinters from a wooden back support, and it is extremely durable
- ↳ Tested to and beyond a 1,134 kg (2500 lb) static load test threshold

- Titan SS One-Piece, Regular #RE11019999
- Titan SS One-Piece, Tapered #RE11009999
- Titan SS Two-Piece, Regular #0107975
- Titan SS Two-Piece, Tapered #RE11049999
- Titan SS One-Piece, Extra-Wide #RE11029999

1 Titan Two-Piece separates in half for compact storage and backpacking to a rescue site.

2 LocSafe™ connectors provide provide fail safe connection.

3 StratLoad™ attachment points provide secure bridle attachment.



SPECIFICATIONS

| | Dimensions L,W,H | Weight | Shipping Weight | Load Rating |
|-----------------------------|------------------|---------|-----------------|-------------|
| One-Piece Regular | | | | |
| Imperial | 83½x23x7¼ in. | 30 lb | 38 lb | 2500lb |
| Metric | 2120x580x180 mm | 13.6 kg | 17 kg | 1134 kg |
| Two-Piece Regular | | | | |
| Imperial | 83½x23½x7½ in. | 33 lb | 39 lb | 2500lb |
| Metric | 2120x600x190 mm | 16 kg | 17.5 kg | 1134 kg |
| One-Piece Extra-Wide | | | | |
| Imperial | 83½x32x7¼ in. | 42 lb | 51 lb | 2500lb |
| Metric | 2120x810x180 mm | 19 kg | 23 kg | 1134 kg |
| One-Piece Tapered | | | | |
| Imperial | 83½x23x7¼ in. | 30 lb | 38 lb | 2500lb |
| Metric | 2110x580x180 mm | 13.6 kg | 17 kg | 1134 kg |
| Two-Piece Tapered | | | | |
| Imperial | 83½x23½x7½ in. | 33 lb | 39 lb | 2500lb |
| Metric | 2120x600x190 mm | 15 kg | 17.5 kg | 1134 kg |



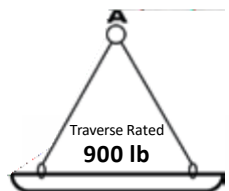

Gazelle Series Carbon Steel Basket Stretchers

- ↳ Designed to be used in raise/lower rescue operations
- ↳ All-carbon-steel, MIG welded frame construction
- ↳ Tubular 3/4" (19 mm) top frame and lower rails
- ↳ Two flat carbon steel supports at the bottom of the stretcher
- ↳ Polyethylene netting does not corrode and is easy to replace
- ↳ Regular model fits any style 16" or 18" backboard
- ↳ Tapered model allows easier access in confined areas
- ↳ Confined Space model allows access to smaller and narrower spaces

- Gazelle Stretcher, Tapered #110106
- Gazelle Stretcher, Regular #110105
- Gazelle Stretcher, Confined Space #110107



Tapered Regular Confined Space

SPECIFICATIONS

| Gazelle | Length | Width | Height | Weight | Load Rating | Shipping Weight | CE | |
|--------------------|---------|---------|--------|---------|-------------|-----------------|------------------|--|
| | | | | | | | Shipping L, W, H | |
| Tapered/Reg. Imp. | 82½ in. | 24¼ in. | 7 in. | 28.5 lb | 900 lb | 41 lb | 87x25x8in. | |
| Tapered/Reg. Met. | 2100 mm | 620 mm | 180 mm | 13 kg | 408 kg | 18.6 kg | 2209x635x203mm | |
| Conf. Space Imper. | 82½ in. | 18¾ in. | 7 in. | 31 lb | 900 lb | 39 lb | 87x25x8in. | |
| Conf. Space Metric | 2100 mm | 460 mm | 180 mm | 14 kg | 408 kg | 17.7 kg | 2209x635x203mm | |

Traverse Rescue® Bradco Stretcher

- Ì Heavy-duty, all-aluminum frame construction and a high-density, polyethylene shell with a spring loaded patient support and restraint system make this stretcher ideal for any rescuesituation
- Ì Patient support bed holds the patient several inches off the bottom frame, which provides a smooth and comfortable ride
- Ì Double flap cover and patient restraint strap system allows patient to be transported in almost any position in maximum comfort and security
- Ì Polyethylene shell allows stretcher to glide smoothly over various types of terrain and surfaces.
- Ì Resistant to chemical agents such as chlorine and petroleum products
- Ì UV inhibitors reduce fading and deterioration from long-term exposure to direct sunlight

The Bradco Stretcher System comes complete with basket stretcher, patient support and restraint system and four lifting straps. Optional dust/storage cover is also available.



Bradco Stretcher System#RE01230499

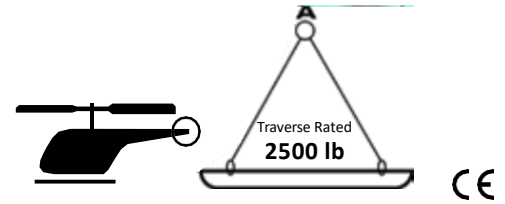

Advantage Basket Stretcher

- Ì Heavy-duty, stainless steel frame construction and a HMWPE shell make this stretcher ideal for any rescuesituation
- Ì Polyethylene shell allows the stretcher to glide smoothly over various types of terrain and surfaces
- Ì Internal secondary rail is completely accessible and provides unlimited options for tying-in a patient for any type of rescue operation
- Ì Replaceable patient pad is made of closed-cell foam which will not absorb fluids
- Ì StratLoad™ attachment points



Advantage Basket Stretcher with SS frame#RE11250399

Dust Cover for Advantage Basket Stretcher#0822069



StratLoad™ attachment point

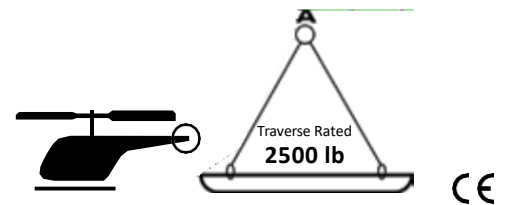

SPECIFICATIONS

| | Length | Width | Height | Weight | Shipping Weight | Load Rating |
|--------------------|---------|--------|--------|--------|-----------------|-------------|
| Bradco Imperial | 80½ in. | 25 in. | 8½ in. | 46 lb | 54 lb | 2500lb |
| Bradco Metric | 2040 mm | 640 mm | 220 mm | 21 kg | 24½ kg | 1134 kg |
| Advantage Imperial | 85 in. | 24 in. | 7½ in | 33 lb | 41 lb | 2500lb |
| Advantage Metric | 2160 mm | 600 mm | 190 mm | 15 kg | 18.6 kg | 1134 kg |

Traverse Rescue® Tablu Tri-Fold Stretcher

The Traverse Rescue® Tablu Tri-Fold Stretcher represents the ultimate in simplicity and durability. It is ideal for vehicle extraction because of its compact size and rapid deployment. The Tablu is made of lightweight aluminum and has zero risk of fire hazards, cracking, warping, and gouging that are common with plastic and composite boards in tactical and vehicle operations. The Traverse Rescue® Tri-Fold Evacuation Board has generous handholds and accepts all common strap systems.



Traverse Rescue Tablu Tri-fold Stretcher, Blue#0108025



Mule Litter Wheel

- ↳ Designed to be "universal" and accept any type of rigid litter including makeshift litters made from wooden planks or logs
- ↳ All-terrain, single-wheel design allows for ease of movement in rough terrain
- ↳ Travels easily over logs, ruts, roots, rocks, snow, and slopes
- ↳ Two securing straps (2 hooks per strap) are rated to 4500 kg
- ↳ The unique uni-support design allows for the wheel to be quickly and easily removed for more compact storage and transport
- ↳ New, improved handles with 8 positions for greater user flexibility
- ↳ Handles lock in down position, allowing the Mule and Litter to stand free of operator



Mule II Litter Wheel with 8-Position Handles, Black#11-2220

Mule II Litter Wheel, without Handles, Black#11-2210



Critter RIT Tool

- ↳ Reduces friction of downed firefighter dragging on the ground which reduces energy and air consumption used by Rescue Team for removal
- ↳ Keeps injured firefighter 4" off the ground underneath the superheated combustible gasses during extrication from the IDLH environment
- ↳ Can attach a pulley to the head of the Critter for going up stairs creating a 2:1 mechanical advantage reducing the weight of the downed firefighter by half
- ↳ Lightweight and compact that can be deployed in seconds
- ↳ Includes low profile wheels on the four corners and 2 restraints



Critter RIT Tool Contact Traverse Rescue

SPECIFICATIONS

| | Length | Width | Height | Folded (L,W,H) | Weight | Shipping Weight | Load Rating |
|----------------------|---------|---------|--------|----------------|--------|-----------------|-------------|
| Tablu Imperial | 71 in. | 16 in. | | 25x16x4 in. | | | |
| Tablu Metric | 1814 mm | 406 mm | | 627x406x99 mm | | | |
| Mule w/ Handles Imp. | 96 in. | 27½ in. | 18½ in | | 46 lb | 58 lb | 395lb |
| Mule w/ Handles Met. | 2440mm | 700 mm | 470 mm | | 21 kg | 26½ kg | 179kg |
| Mule Imperial | 33 in. | 26 in. | 18½ in | | 36 lb | 48 lb | 395lb |
| Mule Metric | 830 mm | 650 mm | 470 mm | | 16½ kg | 22 kg | 179kg |

Traverse Rescue® Stretcher (TRS)

- ↳ Designed and constructed for both horizontal and vertical casualty evacuations
- ↳ Lightweight and compact design makes it ideal for high angle, confined space, back country and helicopter rescue operations
- ↳ Wrap-around concept helps protect arms and sides from injury during evacuation procedures and gives patient a sense of security
- ↳ Inner layer made from a tough high-density polyethylene sheet, which gives the stretcher its rigidity when curved around the patient
- ↳ Base fabric of outer shell is made of 1350 Denier Cordura® nylon with heavy polyurethane coating, and is specially-woven for maximum cut and abrasion resistance
- ↳ Top layer of outer shell is made from 1000 Denier Cordura® nylon making it tough but comfortable for patient to lay on
- ↳ Carry handles and vertical lift attachment points are made from 51 mm (2 in.) webbing and are designed as structural attachment points for a lifting bridle
- ↳ Plastic tubing on the carry handle provides a much more comfortable hold for rescuers
- ↳ Built-in, color-coded, full body adjustable harness restrains the patient securely in the stretcher
- ↳ Padded straps in the shoulder and groin areas provide a comfortable fit, and the foot strap prevents the patient from sliding down during vertical lifts
- ↳ Six, 2" outer-web restraint straps secure the patient into the stretcher by wrapping the stretcher around the patient's body using a 2-bar, 3-bar steel buckle system which is fast and easy to work with, even with gloves on
- ↳ Includes a Cordura® storage bag with backpack shoulder straps
- ↳ Accessories sold separately

Traverse Rescue® Stretcher (TRS)#0107977

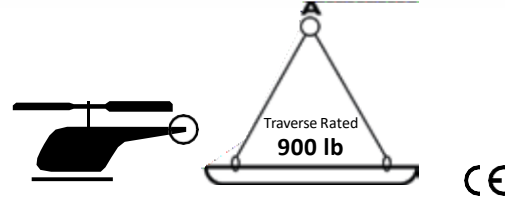

Vertical Rescue Stretcher

The Ferno Vertical Rescue Stretcher's roll-up, compact and lightweight design makes it ideal for high angle, confined space, horizontal or vertical rescue. When deployed the wrap-around concept becomes rigid and gives the patient a feeling of security as well as protecting limbs and body from further injury during evacuation procedures.

- ↳ Designed for both horizontal and vertical lifting
- ↳ Ideal for confined-space rescue, medical airlift evacuations, industrial sites and outdoor rescue
- ↳ Color-coded full body restraint system with padded head restraint, groin and feet straps
- ↳ Supplied with backpack storage bag
- ↳ Includes six, color-coded, non-adjustable lifting slings
- ↳ Maximum load limit: Horizontal 350 kg / Vertical 250 kg
- ↳ Optional VRS 6 Point Adjustable Lift Bridle

Vertical Rescue Stretcher#VRES STRETCH
 Vertical Rescue Stretcher, Camo#VRES STRETCH CAM
 VRS 6 Point, Adjustable Lift Bridle#BRB-VRS

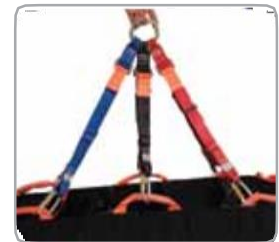

VRS 6Point, Adjustable Lift Bridle



SPECIFICATIONS

| | Length | Width | Weight | Load Rating |
|--------------|---------|--------|--------|-----------------------------|
| TRS Imperial | 80 in. | 38 in. | 18 lb | Horz. 772 lb / Vert. 551 lb |
| TRS Metric | 2020 mm | 840 mm | 8 kg | Horz. 350 kg / Vert. 250 kg |
| VRS Imperial | 80 in. | 30 in. | 18 lb | Horz. 772 lb / Vert. 551 lb |
| VRS Metric | 2020 mm | 770 mm | 8 kg | Horz. 350 kg / Vert. 250 kg |

LifeSaver Rescue Stretcher®

- ↳ Modern version of the traditional Neil Robertson stretcher, the LifeSaver provides patient immobilization and packaging in confined conditions where minimum bulk is a consideration
- ↳ Ideal for mine rescue, wilderness search/rescue, construction sites, building collapse and confined-space rescue
- ↳ Provides quick, easy use in horizontal/vertical lift situations
- ↳ Includes integral leg and torso flaps, simple head restraint, 5 built-in patient restraints and long footstrap
- ↳ Compact roll-up design makes transport easy

LifeSaver Rescue Stretcher #FWELS
 LifeSaver Rescue Stretcher, Camo #FWELS-C



Res-Q-Mate Litter

- ↳ Res-Q-Mate litter with shoulder harness and carry handles
- ↳ Specially designed for use in restricted-access areas, including building collapse, mine rescue, quarry accidents, high-angle rescue and confined-space rescue
- ↳ Constructed of quality synthetic materials and stainless steel
- ↳ Resistant to rot and corrosion. Unaffected by long-term storage
- ↳ Easily adjustable color-coded restraints secure the chest, thighs and lower legs
- ↳ Impervious to water, oil, grease and other petroleum products

Res-Q-Mate Litter with Carry Case and Lift Bridle Model 2060
 Res-Q-Mate Shoulder Harness Pair Model 2061
 Res-Q-Mate Carry Handles Pair Model 2062



Shown with optional carry handles and shoulder harness

Paraguard™ Excel Rescue Stretcher

Paraguard™ has been the official NATO rescue stretcher since WWII, and is used extensively in underground, earthquake and other emergency situations. It can be used for horizontal and vertical lifting, and is ideal stretcher for underground, confined space, and rescue from height. Both lightweight and compact, the Paraguard™ is not only easy to carry but easy to use and can be ready in seconds. Folding in half makes it simple to carry and store.

- ↳ Made from high-quality aluminum and materials resistant to flame, corrosion, and rotting
- ↳ Can be carried using four integral side handles that clip out of the way when not in use
- ↳ Unique construction allows the center to unlock and bend for use in awkward spaces
- ↳ Impervious to water, grease and oils

Paraguard Excel Rescue Stretcher #010795401
 Paraguard Four Point Sling #010773001
 Paraguard Slot In Carry Handles #010772700
 Paraguard Shoulder Harness #010772801
 Paraguard Foul Weather Sheet #010772900



CE

Traverse Rescue® 540° Rescue Belay

- Ì Self-locking belay device that meets demanding drop-test criteria
- Ì Built-in release lever releases the tension on the belay rope, eliminating the need for a release hitch
- Ì Large 540° rescue belay (blue) is designed for use with kernmantle rescue rope from 11.5 mm to 13 mm
- Ì Small 540° rescue belay (green) is designed for use with kernmantle rescue rope from 11 mm to 11.5 mm
- Ì Weight: 1.5 lb. (680 g). MBS 27kN (Large), 23kN (Small)
- Ì UL® Certified to NFPA 1983 (2012 Ed.) General Use



- 540° Rescue Belay, Small, Green#RR01009900
- 540° Rescue Belay, Large, Blue#RR01009902

OG1 Prusik Minding Pulley

- Ì Distinctive design with the combination of a side opening plate with a unique stainless steel gate that allows you to access the sheave without having to disconnect the pulley from its anchor or carabiner
- Ì Accommodates up to three 12 mm carabiners at its connection point
- Ì Made from high grade anodized aluminium and stainless steel
- Ì 36 kN load rating
- Ì Sheave size: 51 mm x 13 mm

Order from Ferno Australia
 Website: www.Ferno.com.au



Traverse Rescue® Litter Bridle

- Ì Litter bridles intended for use with any style litter
- Ì Hardware meets NFPA and military specifications
- Ì "O" ring for top tie-in point is rated 134 kN (30,000 lb)
- Ì Parachute buckles allow independent adjustment to set the best basket angle for patient comfort
- Ì Rated strength for bridle is 22kN (5,000 lb) / 2,268 kg

- Hard Eye Litter Bridle#0313897
- Soft Eye Litter Bridle#0313898



Large Steel Carabiner

- Ì Large swing gate opening with screw lock closure
- Ì High tensile steel
- Ì 40 kN / 8992 lb rating
- Ì Meets ANSI Z359.1-2007 / Z359.12-2009

- Large Steel Carabiner#0822420



Ferno® FDU

Ideal for personal rescue, emergency escape, rescue operations or specialized rope work as a friction control, double stop descending system. The system gradually releases its load when the handle is moved towards the central position. The double stop mode locks should a panic grab happen but unlocks progressively when the handle is released. The Ferno FDU is available with a friction rack for rescue loads (2 persons). Extensively tested and certified to AS/NZS 4488.1:1997 with 11 mm rope.

- FDU100 with Friction Rack#FWE-FDU100
- FDU200 without Friction Rack.....#FWE-FDU200



Ferno® Mini Haul Kit

- ↳ Extremely compact haul kit
- ↳ Provides a 6:1 mechanical advantage
- ↳ Features a V-shaped cleat that if required, enables the operator to lock off the system during a hauling operation
- ↳ Rated for one person rescue only

- Ferno Mini Haul Kit.....#VKIT MINI HAUL



Res-Q-Link Recovery Pole

The Res-Q-Link is a unique and multi functional rescue pole incorporating many features and benefits including:

- ↳ Large alloy double-action hook compatible with most recovery systems and allows two configurations to provide versatility when rescuing a fall victim
- ↳ Extendable from 150 cm to 280 cm (59 to 110 in.)
- ↳ Fiberglass outer pole and rubber-coated handle for maximum grip and control in long reach scenarios
- ↳ Flashlight holder for low light scenarios which is compatible with most slim line flashlights
- ↳ Rope and web cutting knife to cut victim free once a recovery system is attached
- ↳ Additional double action hook available (Code VCT L3536201)

- Res-Q-Link Recovery Pole.....#FWE2090



Spreader Bar

- ↳ Used in confined space situations and rescue scenarios
- ↳ Attaches to confined space pick up points on harness shoulder straps
- ↳ AS/NZS 1891.1:2007 approved

- Spreader Bar.....#VAI SPREADER SHA



IndustriPOD®

The IndustriPOD® is a rugged and versatile tripod with built in safety factors that exceeds internationally recognized rescue systems and standards. Its simplistic but unique design makes it ideal for heavy duty confined space requirement where guaranteed performance is mandatory.

The IndustriPOD's® design allows for a 550 kg load (tested to 5500 kg) off the centre eyebolt and 360 kg loads (tested to 3600 kg) off the side plate attachment points making it one of the strongest tripods on the market.

- ↳ Rectangular, fully adjustable legs with quick action lock leg pins
- ↳ One-piece fabricated steel head
- ↳ Adjustable foot with aggressive non-slip tread pattern
- ↳ One swivel eyebolt
- ↳ Three carabiner attachment points
- ↳ Three tie off points for rigging or stabilization

IndustriPOD® #FWE-INPOD



Arachnipod

The Ferno Arachnipod is the world's most versatile modular total edge management system (TEMS). Components can be added or removed to suit structural or natural features. The unique design of the patent pending modular head allows the Arachnipod to be constructed into many configurations including a ginpole/monopole, bipod, tripod, quadpod, bridge system and handrail recovery monopole. Its versatility makes it an ideal system for workers in industries such as rescue and emergency services, construction, military, utility services, mining, film and maintenance. Approved to CE Standard EN 795B.

The Arachnipod, in its basic form, is a simple tripod with the three legs independently pivoting from an anodized aluminium head. The modular head has a similar design to a door hinge. Inserting or removing a pin through the centre of the head allows the quick and simple addition or removal of components to create a configuration to suit any edge management scenario. Each head section contains a shackle for guying while an optional in-built twin grooved stainless steel pulley is also available.

The Arachnipod flat packs for simple and convenient storage and the modular design provides an option to purchase a basic unit and upgrade components to make a more advanced system. There are numerous kits available ranging from the basic tripod through to a total edge management system (TEMS). The table opposite will help you decide which kit is best for your specific needs.

Arachnipod Contact Ferno Australia



Ultralite X Harness

The Ultralite X Harness weighs just 1.35 kg and features a cross-style design of webbing attached to pliable, supportive mesh padding that provides an even load distribution to the torso in the event of a fall.

- ↳ Non-metallic front and rear free fall arrest attachment points
- ↳ Confined space retrieval attachment points
- ↳ Lightweight alloy quick-connect leg buckles
- ↳ Simplistic design and shape allows easy donning
- ↳ 3D breathable mesh and oil, grease, and water repelling webbing
- ↳ Certified to EN 361 and AS/NZS 1891.1:2007
- ↳ Available S/M, M/L or L/XL. Conditions apply for XS and XXL

Ultralite X Harness#VHI ULTRALITEX



Challenge Pro Series Harnesses

- ↳ Front and rear free fall arrest attachment points
- ↳ Confined space retrieval attachment points
- ↳ Lightweight alloy quick connect buckles and components
- ↳ Generous size adjustment and simplistic design allows easy donning
- ↳ Removable, reflective and padded shoulder/back panel
- ↳ 3D breathable mesh and oil, grease, and water repelling webbing
- ↳ Reflective for exceptional night time visibility
- ↳ Available with integral PFD and flame retardant/cut resistant Kevlar
- ↳ Certified to EN 361, AS/NZS 1891.1:2007 and CASA Helicopter External Personnel Lifting Devices
- ↳ XS,S/M, M/L and XL. Conditions apply XS and XL

Challenge Pro Harness - Standard#VHI CHG PRO
 Challenge Pro w/ Personal Flotation Device(PFD)#VHI CHG PRO PFD
 Challenge Pro Harness - Kevlar#VHI CHG PROK
 Challenge Pro Harness - Kevlar w/ PFD#VHI CHGPROK PFD



Ferno® Centrepont II Full Body Harness

- ↳ Confined space retrieval and offset (cranked) pole strap attachment points
- ↳ High & low front and rear free fall arrest attachment points
- ↳ Quick connect lightweight buckles and gear loops for additional gear
- ↳ Large, cushioned mesh waist/leg pads with breathable back/neck pads
- ↳ Reflective for exceptional visibility
- ↳ Oil, grease and water repelling webbing
- ↳ All alloy hardware and adjustable leg risers for best fit
- ↳ Certified to EN 361 and AS/NZS 1891.1:2007
- ↳ XS, S/M, M/L & XL. Conditions apply XS and XL

Centrepont II Full Body Harness#VHI CEN FB 2
 Centrepont II with Ascender#VHI CENFB 2 A



Patient Lifting Sling

The retrieving victims where time and rescue is of the essence. Simple to apply and fully adjustable in confined and difficult situations. The underarm strap with securing buckle and adjustable leg loops ensure a secure hold. Certified to CASA Helicopter External Personnel Lifting Devices.

Patient Sling#VRES PAT LIFT+



Vertical Rescue Triangular Harness

The Vertical Rescue Triangular Harness is a simple yet robust patient lifting sling designed for all forms of rapid vertical extractions. The simple design allows the harness to be applied to the patient easily and quickly. This harness is not suitable for patients with suspected spinal injuries.

Vertical Rescue Triangular Harness#VRES TRI HARN



Kigali Backpacks

Kigali backpacks are available in three sizes: 30, 35 and 45 liters. Each pack includes two external pockets with double elastic loops to organize small items. The large top-opening main compartment has additional pockets for large dressings and hydration systems. Each pack has enough space for a BVM, small blankets, dressings and collars.

- Ì Removable white cross
- Ì Built-in rain cover
- Ì Easy-grab zipper pulls with large #10 YKK® zipper

Kigali 30 (30 liter)

Features a molded back support, padded shoulder strap, web waist belt and a rubber-grip grabhandle

Kigali 30, Red#RE00300399

Kigali 35 (35 liter)

Features a molded back support, padded shoulder strap, a padded waist belt and a rubber-grip grabhandle

Kigali 35, Red#RE00350399

Kigali 35, Black#RE00350999

Kigali 45 SAR Backpack (45 liter)

Ì Advanced, adjustable harness system with two aluminum stays

Ì Designed to carry one "D" cylinder oxygen system

Ì Heavily-padded waist belt

Ì Designed to carry heavy loads

Ì Available in black and red

Kigali 45, Red#RE00450399

Kigali 45, Black#RE00450999



contents not included

Medical Data Carrier™

In an emergency, Medical Data Carrier™ will provide lifesaving information about the wearer. The highly visible and secure carrier attaches to the left side of the individual's rescue or fire helmet and is safe for all helmet surfaces. Inside, a two-sided waterproof paper contains information on the wearer's identity and medical history including information such as allergies, medications, and blood type.

Medical Data Carrier™#CANMEDIDAT



Traverse RDC

Swiftwater rescue is safe and sure with Traverse's RDC Rapid Deployment Craft inflatable rescue raft. The RDC allows a rescuer or rescue team to quickly reach a victim and safely retrieve them in swift water, whitewater, floods or low head dam entrapment situations.

The RDC is easy to control, very stable and is self-righting in potential overturn situations. It paddles and ferries like a canoe and is suitable for class or grade 5 whitewater. Where swiftwater rescue situations permit, the RDC can be shore controlled by tethers from one or two rescuers. Or, it can be easily paddled by one or two rescue technicians.

- Ì The RDC stores deflated in a 2 foot cube
- Ì Will fit in the trunk of almost any passenger car
- Ì Inflates in seconds
- Ì Weighs 50 pounds and can be easily carried by one person
- Ì Can be launched without access to a boat ramp
- Ì Can be on the scene and in action in seconds
- Ì 5 Year Manufacturer Warranty

Traverse RDC [Contact Traverse Rescue](#)



Rescue Boat Sea Scoopa

The Sea Scoopa is designed for the rescue/retrieval of a man overboard (MOB) in a horizontal or vertical floating position. Its unique design enables the crew to complete the rescue operation without entering the water.

The Sea Scoopa net prevents the MOB being swept out the aft end and has no large openings which can lead to limb entrapment or risk of drowning in difficult conditions. The scoop encloses and conforms to the whole body and minimizes the risk of MOB falling out during lifting. The two poles enables the mouth of the net to be widened to maximize capture surface and gives rescuers extra reach, better control and visibility during the rescue process.

Strategic handle placements assists lifting the MOB in a horizontal position and the 2:1 mechanical advantage reduces the lift load by 50%. The Sea Scoopa includes an integral stretcher that clips on to the rescuers' safety harness allowing the MOB to be stretchered immediately after water retrieval without further handling or need for separate stretcher personnel.

Sea Scoopa [VRES SEACOOP](#)

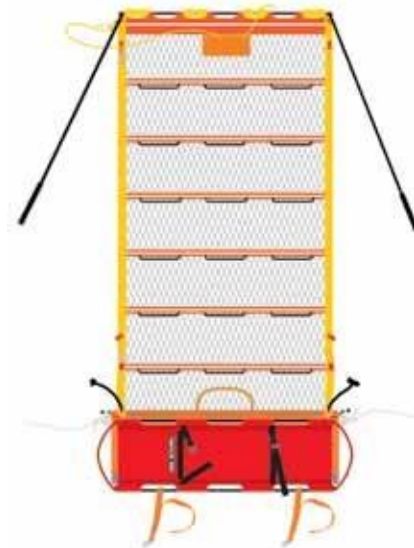

Saver Model S-219 Cot

- Ì The Saver Model S-219 combines easy handling with improved patient comfort.
- Ì Backrest can be locked in one of six positions, from 0 to 76degrees
- Ì Swivel wheels provide smooth, swift movement in any direction
- Ì Wheel locks on two wheels provide added safety
- Ì Includes mattress and restraints

Saver Model S-219#0054159



CE

Saver Model S-240 Patient Transport Chair

The Saver S-240 patient transport chair is easy to maneuver by two operators in cramped quarters. Two 127 mm (5 in.) stationary rear wheels enable operators to move the patient over most surfaces with minimal effort. Telescoping, two-position front handles allow foot-end operator to maneuver the patient without interfering with the patient's feet. Vinyl-coated nylon cover is simple to clean, resists stains, blood and body fluids. Includes three patient restraints. Optional vehicle fastener.

Saver Model S-240#0721324



CE

Saver Model S-242 Patient Transport Chair

The Saver S-242 Patient transport chair is easy to maneuver by two operators in cramped quarters. Two 127 mm (5 in.) stationary rear wheels and 76 mm, front mounted swivel wheels enable personnel to move the patient over most surfaces with minimal effort. Telescoping, two-position front handles allow foot-end operators to maneuver the patient without interfering with the patient's feet. Vinyl-coated nylon cover is simple to clean, resists stains, blood and body fluids. Includes three patient restraints. Optional vehicle fastener.

Saver Model S-242#0721323



CE

SPECIFICATIONS

| | Length | Length Folded | Width | Height Open | Height Folded | Weight | Load Capacity |
|----------------|---------|---------------|--------|-------------|---------------|--------|---------------|
| S-219 Imperial | 94 in. | | 20 in. | 43 in. | 16 in. | 57 lb | 350lb |
| S-219 Metric | 2385 mm | | 515 mm | 1100 mm | 410 mm | 26 kg | 159kg |
| S-240 Imperial | 48 in. | 7 in. | 20 in. | 36 in. | 36 in. | 20 lb | 350lb |
| S-240 Metric | 1210 mm | 170mm | 520 mm | 915 mm | 915 mm | 9 kg | 159kg |
| S-242 Imperial | 48 in. | 7 in. | 20 in. | 36 in. | 36 in. | 22 lb | 350lb |
| S-242 Metric | 1210 mm | 170mm | 520 mm | 915 mm | 915 mm | 10 kg | 159kg |

Saver Model S-242T Chair

Saver S-242T chair is an ideal cost-effective solution to complement Ferno's range of evacuation chairs. Lightweight and compact, the chair provides a comfortable and safe transfer for both the occupant and operator. Great features from the proven and popular 59T EZGlide® and Compact 4 chairs are combined with even more user benefits in the Saver brand.

- ↳ Easy, instant deployment
- ↳ Sturdy construction for ultimate safety
- ↳ Supportive seat and head pad for comfort and easy transfer
- ↳ Secure 4-point shoulder restraint
- ↳ Foldable foot rest with leg straps

Saver Model S-242T#60-0110-015



CE

Saver Safe Evacuation Chair

The Saver Safe Evacuation chair is a single user operation emergency evacuation chair and is the complete solution for any emergency evacuation situation. The chair glides down stairs easily and smoothly to ensure no heavy lifting or manual handling is required. The operator never has to assume the weight of the chair and patient.

- ↳ Low, adjustable, easy-grip handle improves operator control and comfort
- ↳ Vinyl seat is attached all around, providing safe lateral patient transfers
- ↳ Head pad is adjustable and removable for patient comfort
- ↳ Restraints are adjustable for patient security
- ↳ Includes 6 foot restraints to accommodate all body shapes and sizes
- ↳ Chair is lightweight, with a compact profile for easy storage and use
- ↳ Available with wall bracket, cover, and user instructions
- ↳ Weight capacity of 180 kg (397lb)

Saver Safe Evacuation Chair#0721328



CE

SPECIFICATIONS

| | Height Min | Height Max | Width | Depth | Depth Track Deployed | Depth Folded | Weight | Max Load |
|-------------------|---------------|---------------|--------|--------|-------------------------|-----------------|---------|-------------|
| S-242T Imperial | 51 in. | 61 in. | 19 in. | | | 9 in. | 35 lb | 397 lb |
| S-242T Metric | 1290 mm | 1555 mm | 480 mm | | | 225 mm | 16 kg | 180kg |
| Saver Safe Imper. | | 43 in. | 17 in. | 27 in. | 37 in. | 8 in. | 36 lb | 397lb |
| Saver Safe Metric | | 1100 mm | 430 mm | 690 mm | 930 mm | 200 mm | 16.4 kg | 180kg |

Saver Model S-2108A/S-2108AF Pole Stretchers

- ↳ Lightweight aluminum poles for easy lifting and exceptional durability
- ↳ Non-slip plastic carrying handles
- ↳ Spreader bars provide additional support
- ↳ Vinyl fabric is impervious to stains and mildew for easy cleaning
- ↳ Stirrup feet raise the patient off the ground
- ↳ Carrying bag available for both models

2108A Single Fold

- ↳ Collapsible spreader bars allow the stretcher to fold in width to a slim shape for storage

Saver Model 2108A, Blue #600102007

2108AF TwoFold

- ↳ Folds in both length and width to an extremely compact size

Saver Model 2108AF, Blue #600102005



CE

Saver Model S-2032 Stacking Catastrophe Stretcher

- ↳ Lightweight, stackable stretcher stores easily and deploys quickly for mass catastrophe and multiple casualty situations.
- ↳ The heavy-duty vinyl-coated nylon cover is durable, fire retardant and resistant to stains from blood and body fluids

Saver Model S-2032, Orange #600106001

Saver Model S-2032, Blue #SAV-002

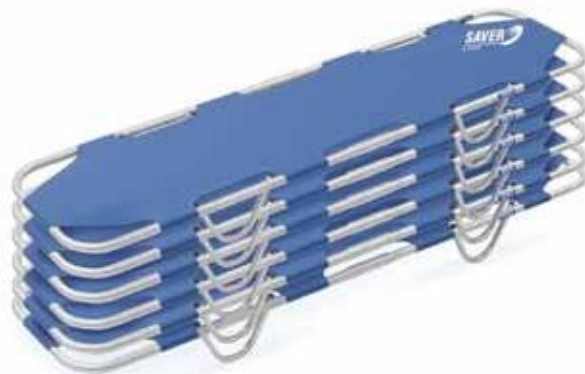

CE

SPECIFICATIONS

| | Length | Length Folded | Width | Width Folded | Height | Height Folded | Weight | Load Capacity |
|-----------------|---------|------------------|--------|--------------|--------|-----------------|-----------------|---------------|
| S-2108 Imperial | 81 in. | 41 in. (2108AF) | 22 in. | 4 in. | 6 in. | 8 in. (2108AF) | 11/13 lb (A/AF) | 350lb |
| S-2108 Metric | 2060 mm | 1030 mm (2108AF) | 550 mm | 110 mm | 140 mm | 200 mm (2108AF) | 5/6 kg (A/AF) | 159kg |
| S-2032 Imperial | 74 in. | | 19 in. | | 7 in. | | 6.5 lb | 350.5lb |
| S-2032 Metric | 1870 mm | | 480 mm | | 180 mm | | 3 kg | 159kg |

Saver S-2445 Head Immobilizer

- ↳ A versatile, secure head support can be used on standard backboards or inverted for use on any scoop stretcher.
- ↳ Features two plastic-coated, closed-cell foam head supports, one universal attachment base, and two durable head straps
- ↳ Base plate fits all wooden, aluminum, and plastic backboards and scoop stretchers



Saver Model S-2445 Head Immobilizer#0314027

CE

Saver Vacuum Splints

Full Body

Designed to make lifting as comfortable as possible for both patient and rescuer.

- ↳ One-piece back provides patient with even spine support
- ↳ 12 handles (6 on each side), featuring ergonomic grips for secure, comfortable handling
- ↳ Eight eyelets (4 on each side) to install belts
- ↳ Granule-filled mattress allows mattress to be molded to body
- ↳ Flame retardant, EN 1865 approved

Saver Full Body Vacuum Splint#15005002230



Short Arm

Molds around the patient's fracture to give optimal support and stabilization during transport.

- ↳ Suitable for patients with hand, wrist, arm, leg, shoulder, or hip injuries
- ↳ Immobilizes lower leg on adults
- ↳ Immobilizes full leg, hip or shoulder on children

Saver Short Arm Vacuum Splint#15005002032



Long Arm /Short Leg

Immobilizes arm, forearm, wrist, ankle, and knee fractures safely and effectively.

Saver Long Arm/Short Leg Vacuum Splint#15005002033



Long Leg

Secure immobilization for leg injuries.

Saver Long Leg Vacuum Splint#15005002034

CE

Saver Frac Immobilizers

A simple way to splint and immobilize suspected limb fractures while helping to prevent further damage to surrounding nerves and tissue.

- ↳ Can accommodate a splint board to extend length of splint
- ↳ Easy to clean for re-use
- ↳ Supplied with additional vinyl-coated pad for enhanced patient comfort
- ↳ Hook and loop strapping secures the splint around the injured limb
- ↳ Can remain in place during X-rays

Saver Frac Immobilizer, 2 Straps#SAV017

Saver Frac Immobilizer, 4 Straps#SAV018

Saver Frac Immobilizer, 5 Straps#SAV019

2 Straps
(510x 330 mm)



4 Straps
(740x 610 mm)



5 Straps
(1090x 690 mm)



CE

24-miniMAXX® Mortuary Cot

The 24-miniMAXX® features true independent legs with multi-level adjustment, six-inch wheels, dual hand controls, and a distinguished, durable gloss-black powder-coated finish. An industry-leading 1000 lb load capacity allows users to handle large bodies with ease. The narrow bed surface gives the 24-miniMAXX® increased maneuverability and allows two cots to be placed side-by-side in the rear of most vehicles. The 24-miniMAXX® comes complete with a 1-inch mattress and restraints. Compatible with most Ferno covers and pouches.

| | |
|--|----------|
| 24-miniMAXX Mortuary Cot..... | #0032501 |
| 24-miniMAXX with Sidearms..... | #0032502 |
| 24-miniMAXX with Side Lift Handles..... | #0032503 |
| 24H-miniMAXX Cot (150 mm / 6 in. higher) | |
| 24H-miniMAXX Mortuary Cot..... | #0032504 |
| 24H-miniMAXX with Sidearms..... | #0032505 |
| 24H-miniMAXX with Side Lift Handles..... | #0032506 |
| 24-miniMAXX Mattress..... | #0314042 |



Model 24 Mortuary Cot

- Ì Roll-In technology allows just one person to perform retrieval
- Ì Multi-level feature allows body to be moved easily from bed to cot
- Ì Special release levers make it possible to raise and lower the cot without assuming the full weight of the cot and body
- Ì Load-end legs unfold and lock automatically when unloading the cot
- Ì Slides down stairs with built-in stair glides
- Ì Includes mattress and restraints

| | |
|---|----------|
| Model 24 with Footrest, without Sidearms..... | #0032400 |
| Model 24 with Sidearms and Footrest..... | #0032410 |
| Model 24 with Two Wheel Locks and Footrest..... | #0032450 |
| Model 24 with Two Wheel Locks, Sidearms and Footrest..... | #0032487 |
| Model 24-H Cot (102 mm / 4 in. higher) | |
| Model 24-H with Footrest, without Sidearms..... | #0032420 |
| Model 24-H with Sidearms and Footrest..... | #0032490 |
| Model 24-H with Two Wheel Locks and Footrest..... | #0032488 |
| Model 24-H with Two Wheel Locks, Sidearms and Footrest..... | #0032486 |



Model 27-1 Mortuary Cot

- Ì Very maneuverable in close quarters with four swivel wheels, tapered head end and folding end section to shorten the cot
- Ì The multi-level undercarriage provides flexibility in retrieval
- Ì The loading-end wheels can be locked when necessary
- Ì Includes mattress and restraints

| | |
|--|----------|
| Model 27-1 Mortuary Cot, without Sidearms..... | #0032485 |
| Model 27-1 Mortuary Cot, with Sidearms..... | #0032484 |



SPECIFICATIONS

| | Length | Width | Height Max | Height Folded | Weight | Load Limit | Shipping Weight | Shipping L,W,H |
|-------------------|---------|--------|------------|---------------|--------|------------|-----------------|----------------|
| miniMAXX Imperial | 76 in. | 24 in. | 33½ in. | 14 in. | 76 lb | 1000 lb | 100 lb | 83x26x13 in. |
| miniMAXX Metric | 1930 mm | 600 mm | 854 mm | 349 mm | 34 kg | 454 kg | 45 kg | 2108x660x330mm |
| 24 Imperial | 76 in. | 21 in. | 32¼ in. | 10 in. | 54 lb | 400 lb | 75 lb | 83x26x13 in. |
| 24 Metric | 1930 mm | 533 mm | 820 mm | 254 mm | 24 kg | 181 kg | 34 kg | 2108x660x330mm |
| 27-1 Imperial | 79 in. | 24 in. | 34 in. | 10 in. | 62 lb | 400 lb | 85 lb | 83x26x12 in. |
| 27-1 Metric | 2007 mm | 610 mm | 864 mm | 254 mm | 28 kg | 181 kg | 39 kg | 2108x660x305mm |

Model 23 Mortuary Cot

- ↳ Extra long wheel base provides exceptional stability
- ↳ Slide-action leg lock securely locks both sets of legs simultaneously when folded
- ↳ With legs folded and locked, the Model 23 can be used as a two-wheeled stretcher
- ↳ Stair glides reduce wear on the cot and promote smooth movement down stairs
- ↳ Wide enough to accommodate a portable stretcher
- ↳ Includes mattress and restraints



- Model 23 Mortuary Cot, without Sidearms#0032300
- Model 23 Mortuary Cot, with Sidearms#0032489



Model 11-T Stretcher with Track

- ↳ Built-in track system allows easy patient transport down stairs in the supine position
- ↳ Sturdy and lightweight with two front wheels for easy maneuvering
- ↳ Narrow track-to-ground clearance provides easier movement over all surfaces, even with tracks deployed
- ↳ Heavy-duty vinyl coated cover
- ↳ Folds in half for compact storage
- ↳ Integrated folding footrest for safe use and ease of storage
- ↳ Includes two 1524 mm (5 ft) quick-release patient restraints



- Model 11-T, Burgundy#0108026

Retaining Bracket for Model 11-T

Unique fixing bracket to allow a Model 11-T to be transported on top of a Model 24, 24-miniMAXX®, 24-MAXX® or Model 27 cots. Allows both stretchers to be used together during transportation.



- Retaining Bracket for Model 24#069579600
- Retaining Bracket for Model 24-miniMAXX®#069579800
- Retaining Bracket for Model 24-MAXX®#069579900
- Retaining Bracket for Model 27#069579700

SPECIFICATIONS

| | Length | Width | Height Max | Height Min | Weight | Load Limit | Shipping Weight | Shipping L,W,H |
|---------------|---------|--------|---------------|---------------|--------|---------------|--------------------|-------------------|
| 23 Imperial | 76 in. | 21 in. | 32 in. | 10 in. | 44 lb | 400 lb | 70lb | 83x26x13in. |
| 23 Metric | 1920 mm | 530 mm | 800 mm | 240 mm | 20 kg | 181 kg | 32 kg | 2108x660x330mm |
| 11-T Imperial | 76 in. | 20 in. | 8 in. | 8 in. | 24 lb | 350 lb | | |
| 11-T Metric | 1930 mm | 500 mm | 203 mm | 203 mm | 11 kg | 159 kg | | |

Mortuary Scoop EXL®

- ↳ Two halves made from smooth, lightweight, molded polyethylene, for easy application and smooth transfers.
- ↳ Twin Safety Lock® at each end provides fast, easy, nonbinding locking and unlocking
- ↳ Narrow foot-end frame for handling in confined spaces
- ↳ Easy-to-clean surface
- ↳ Foot end extends to four length options to accommodate different patient heights
- ↳ Folds for storage
- ↳ Includes two Model 430, two-piece, 1524 mm (5 ft) burgundy restraints



Mortuary Scoop EXL, Gray with Restraints#0108005

SPECIFICATIONS

| | Length | Width | Height Max | Weight | Load Limit | Shipping Weight | Shipping L,W,H |
|----------------|--------------|--------|---------------|--------|---------------|--------------------|-------------------|
| Scoop Imperial | 65-79 in. | 17 in. | 3 in. | 18 lb | 350 lb | 22lb | 67x18x3 in. |
| Scoop Metric | 1650-2010 mm | 430 mm | 70 mm | 8 kg | 159 kg | 10kg | 1702x457x76 mm |

Model 347-1 Disposable Heavy-Duty Vinyl Disaster Pouch

- ↳ Electronically-welded seams, totally sealed edges
- ↳ Vinyl shell resists abrasions, acid, formaldehyde, blood stains
- ↳ Withstands extreme temperatures
- ↳ Will not leak, deteriorate or mildew
- ↳ 2286x966 mm (90x38 in.) with center opening



Disposable Pouch with U-Shaped Zipper#0314043

Side Extension Panels (SEP)

The SEP provides a new dimension to the operating table. Each sturdy extension panel may be attached to any existing Ferno operating table to expand the surface allowing the embalmer to work on larger bodies. Another key feature of this extension panel is the ability to be used as a splash guard for general washing. The panels can be used on one or both sides of the operating table providing the embalmer increased flexibility. These features, along with the ability to easily install, remove, clean and store the SEP, provide the embalmer the opportunity to customize the table based upon individual needs.

- ↳ Stainless steel panel
- ↳ Fastens to any Ferno embalming table
- ↳ Easy to clean
- ↳ Storage bracket available for Model 101-H or Model 103

SEP Panel Only, 1 Each#0695796
 SEP Storage Bracket, 1 Each#0695797
 SEP Kit, with 2 Panels and 2 Storage Brackets#000SEPKIT



Table sold separately



Model 101-H Hydraulic Table

- Ì Hydraulic foot pedals for tilting and height adjustments
- Ì Lower or raise either end of table from 724 to 1029 mm (28.5 to 40.5 in.) above the floor
- Ì Convex shaped top drains fluids away from the body
- Ì Drain is located in the center of the foot end to quickly eliminate fluids from the table
- Ì Four 203 mm (8 in.) swivel wheels lock instantly with a single foot pedal or one wheel locks directionally for easy rolling
- Ì Type 304 stainless steel with #3 finish ensures easy maintenance
- Ì Solid surface base eliminates crevices where liquids can coagulate
- Ì Accessory: Model 38-BB, Body Bridge (elevates body)



Model 101-H Hydraulic Mortuary Table.....#0661010



Model 102 Folding Operating Table

- Ì Folded table can stand on one end for storage behind a door or in a closet
- Ì Combination table is ideal for embalming and transferring
- Ì Exclusive one-hand release adjusts either end of table from 826 to 978 mm (32.5 to 38.5 in.)
- Ì Ends are independently adjustable
- Ì 152 mm (6 in.) wheels lock to keep table stationary while in use
- Ì Accessory: Model 38-BB, Body Bridge (elevates body)



Model 102 Folding Mortuary Table.....#0661020



Model 103 Combination Operating Table

- Ì Ideal for embalming and transferring
- Ì Each end can be adjusted independently
- Ì Durable and rigid stainless steel top features a convex surface and deep side troughs for efficient, no-splash drainage
- Ì 152 mm (6 in) wheels lock to keep table stationary while in use
- Ì Table is shipped ready for easy assembly for lower freight costs
- Ì Accessory: Model 38-BB, Body Bridge (elevates body)



Model 103 Combination Mortuary Table.....#0661030



SPECIFICATIONS

| | Length | Width | Max Height | Min Height | Wheel Base | Weight | Load Limit | Shipping Weight | Shipping L, W, H |
|----------------|---------|--------|------------|------------|-------------|--------|------------|-----------------|------------------|
| 101-H Imperial | 80 in. | 30 in. | 41 in. | 29 in. | 25x49 in. | 158 lb | 600 lb | | |
| 101-H Metric | 2032 mm | 762 mm | 1029 mm | 724 mm | 622x1232 mm | 72 kg | 272 kg | | |
| 102 Imperial | 80 in. | 30 in. | 39 in. | 33 in. | 27x64 in. | 87 lb | 1000 lb | 105 lb | 83x34x7 in. |
| 102 Metric | 2050 mm | 770 mm | 980 mm | 830 mm | 690x1630 mm | 40 kg | 454 kg | 48 kg | 2108x864x178 mm |
| 103 Imperial | 80 in. | 30 in. | 38 in. | 32 in. | 27x53 in. | 80 lb | 1000 lb | 105 lb | 83x34x7 in. |
| 103 Metric | 2050 mm | 770 mm | 950 mm | 800 mm | 690x1350 mm | 36 kg | 454 kg | 48 kg | 2108x864x178 mm |

Model 88 Church Truck

Designed for those who prefer a compact church truck, the Model 88 extends to 1181 mm (47 in) long. The church truck is constructed of the same rectangular, anodized aluminum tubing used on the Model 87 church trucks. Features 6" (152mm) wheels, and three locking frame positions. Available in onyx, blue-grey, silver, bronze, or gold finish.

| | |
|---------------------------------------|----------|
| Model 88 Church Truck, Clear..... | #0618870 |
| Model 88 Church Truck, Bronze..... | #0618871 |
| Model 88 Church Truck, Gold..... | #0618872 |
| Model 88 Church Truck, Blue/Grey..... | #0618873 |
| Model 88 Church Truck, Onyx..... | #0618874 |
| Model 88-H Church Truck..... | #0618875 |



CE

Model 87 Church Truck

- Ì Rectangular aluminum tubing with anodized finish
- Ì Rubber rest helps secure casket
- Ì 152mm (6 in) swivel wheels with rubber tires
- Ì Four positions allow a wide range of casket sizes
- Ì Maximum load 454 kg (1000 lb)
- Ì Available in silver, gold, bronze, blue-gray, and onyx
- Ì Extends to 1549 mm (61 in)

| | |
|---|----------|
| Model 87 Church Truck, Clear..... | #0618860 |
| Model 87 Church Truck, Bronze..... | #0618861 |
| Model 87 Church Truck, Gold..... | #0618862 |
| Model 87 Church Truck, Blue Gray..... | #0618863 |
| Model 87 Church Truck, Onyx..... | #0618864 |
| Model 87-H Church Truck w/ handles..... | #0618865 |
| Model 87-HB Church Truck, Bronze..... | #0618866 |
| Model 87-HG Church Truck, Gold..... | #0618867 |
| Model 87-HBG Church Truck, Blue Gray..... | #0618868 |
| Model 87-HO Church Truck, Onyx..... | #0618869 |



CE

Cemetery Church Truck

- Ì The cemetery church truck is designed for use over grass and rougher terrain
- Ì 203 mm (8 in) pneumatic wheels
- Ì Two locking swivel wheels opposite corners and two swivels wheels
- Ì Four side handles for lifting over curb
- Ì Maximum load 454 kg (1000 lb)
- Ì Available in onyx, blue-grey, silver, bronze or gold finish

| | |
|---------------------------------------|----------|
| Cemetery Church Truck, Onyx..... | #0618887 |
| Cemetery Church Truck, Blue-Grey..... | #0618886 |
| Cemetery Church Truck, Silver..... | #0618883 |
| Cemetery Church Truck, Bronze..... | #0618884 |
| Cemetery Church Truck, Gold..... | #0618885 |



CE

Flexible Body Fridge

The Flexible Body Fridge provides a quick, cost-effective and practical solution for temporary or permanent cold storage without having to make building modifications. The system uses a unique track and roller system for easy installation and a two-way thermal curtain to keep the cold air in and the ambient air out.

- ↳ Versatile system allows simple assembly, extension and relocation
- ↳ Fully operational within minutes of installation
- ↳ Suitable to divide larger cold rooms
- ↳ Bespoke designs to suit any size room
- ↳ Cold lock skirt adjusts to uneven floors
- ↳ Strong, lightweight curtains are simple to clean and repair

Order from Ferno UK
 Tel: +44 (0) 1274 851999
 Website: www.ferno.co.uk



Compact Body Fridge

The Compact Body Fridge provides an easy solution for temporary cold storage. With a simple, modular design, the freestanding unit provides compact and dependable temporary refrigeration in any indoor or outdoor location – even when access is severely limited.

- ↳ Instant, cost-effective cold rooms for all locations
- ↳ Installed by two operatives within 15-20 minutes
- ↳ Individual chiller unit on sturdy wheeled base
- ↳ Fast refrigeration – just plug the chiller unit into a 13 amp supply or a suitable generator
- ↳ Can be supplied with storm straps, pegs and tie for secure outdoor use

Order from Ferno UK
 Tel: +44 (0) 1274 851999
 Website: www.ferno.co.uk



| MODEL | RESTRAINTS (PAGE 43) | | | | | | | | | | IV POLES (PAGE 41) | | | | | |
|--------------------------|----------------------|----------------|-----------------|-----------------|-----------------------|------------------------|-----------------------|------------------|------------------|----------|--------------------|--------------|----------|------------------|------------------|------------|
| | 417-1 (Black) | 417-1 (Orange) | 417-EFX (Black) | 429 Kit (Black) | 430, 2-pc, 5' (Black) | 430, 2-pc, 5' (Orange) | 430, 2-pc, 7' (Black) | 5126 Krt (Black) | Mondial Monobloc | 513-1 | 513-10 HD NM | 513-11 HD NM | 513-13 | Mondial Monobloc | Mondial RS Mount | 2030 |
| PART # | #0313915 | #0313914 | #0313996 | #0819688 | #0313892 | #0313891 | #0313911 | #0313910 | #63-4500-001 | #1204016 | #0085450 | #0087156 | #0087157 | #0832172 | #00090016 | #LAIV-2030 |
| Mondial Transporter | | | | | | | | | | | | | | | | |
| Mondial RS Stretchers | | ● | | ● | | ● | | | | | | | | | | ● |
| Lift-Off Stretcher Chair | | ● | | ● | | ● | | | | | | | | | | ● |
| Mondial Monobloc | | | | ● | | ● | | ● | | | | | | ● | | |
| Model 17 York 2 Cot | ● | ● | | ● | ● | | | | | ● | | ● | | | | |
| Model 19 York 4 Cot | ● | ● | | ● | ● | | | | | ● | | ● | | | | |
| Model 25 Cot | ● | ● | | ● | ● | | | | | ● | | ● | | | | ● |
| Model 26 Series Cots | ● | ● | | ● | ● | | | | | ● | | ● | | | | ● |
| Model 28 Chair Cot | ● | ● | | ● | ● | | | | ● | | ● | | | | | |
| Model 35A Cot | ● | ● | | ● | ● | | | | | ● | | ● | | | | |
| Model 93ES Cot | ● | ● | | ● | ● | | | | | ● | | ● | | | | |
| Model 5126EL Cot | ● | | | ● | | | | | | ● | | | | | | ● |
| 4051/4052 Transporter | | | | | | | | | | | | | | | | |
| 4141/4142 Stretchers | | | ● | ● | | | | | | | | | | | | |
| 4153 Stretcher | | | ● | ● | | | | | | | | ● | | | | |
| POWERFlexx Cot | ● | | | ● | | ● | | | | ● | | ● | | | | |
| 26P Cot | ● | | | ● | | | | | | ● | | ● | | | | |
| 35X Cot | ● | | | ● | | ● | | | | ● | | ● | | | | |
| 28Z Chair Cot | ● | | | ● | | | | | | | ● | | | | | |
| 93H Cot | ● | | | ● | | ● | | | | ● | | ● | | | | |



| MODEL | MATTRESSES | | | | | | | | | | | | | | | | |
|--------------------------|--------------------------------------|--------------------------------------|-------------------------------------|----------------------------|------------------------------|---------------------------------|-----------------------------------|------------------------------|--------------------------------|--------------------------|----------------------------|-------------------------------|-------------------------------|---------------------------|----------------------------|-----------------------------|---------------------------|
| | Worldial Ext. Bolster (Blk) #0374874 | Worldial Int. Bolster (Blk) #0374875 | Lift-Off Stretcher (Black) #0374855 | 360 Flat (Orange) #0313691 | 360 Flat (Burgundy) #0313692 | 460 Bolstered (Orange) #0312720 | 460 Bolstered (Burgundy) #0313063 | 359-8, 2pc (Orange) #0311220 | 359-8, 2pc (Burgundy) #0313099 | 359-11 (Orange) #0371400 | 359-11 (Burgundy) #0374847 | 359-20 (Orange) #0372100-4141 | 359-20 (Orange) #0372100-4142 | PROFlexx (Black) #0313920 | 28Z, 2-pc (Black) #0314031 | POWERFlexx (Black) #0313997 | 5126 (Black) #65-0560-001 |
| Mondial Transporter | | | | | | | | | | | | | | | | | |
| Mondial RS Stretchers | ● | ● | | | | | | | | | | | | | | | |
| Lift-Off Stretcher Chair | | | ● | | | | | | | | | | | | | | |
| Mondial Monobloc | ● | ● | | | | | | | | | | | | | | | |
| Model 17 York 2Cot | | | ● | ● | ● | ● | | | | | | | | | | | |
| Model 19 York 4 Cot | | | ● | ● | ● | ● | | | | | | | | | | | |
| Model 25 Cot | | | ● | ● | ● | ● | | | | | | | | | | | |
| Model 26 Series Cots | | | ● | ● | ● | ● | | | | | | | | | | | |
| Model 28 Chair Cot | | | | | | | ● | ● | | | | | | | | | |
| Model 35A Cot | | | ● | ● | ● | ● | | | | | | | | | | | |
| Model 93ES Cot | | | ● | ● | ● | ● | | | | | | | | | | | |
| Model 5126EL Cot | | | | ● | | | | | | | | | | | | | ● |
| 4051/4052 Transporter | | | | | | | | | | ● | ● | | | | | | |
| 4141/4142 Stretchers | | | | | | | | | | | | | | | | | |
| 4153 Stretcher | | | | | | | | ● | ● | | | | | | | | |
| POWERFlexx Cot | | | | | | | | | | | | | | | | ● | |
| 26P Cot | | | | | | | | | | | | | | | | ● | |
| 35XCot | | | | | | | | | | | | | | | | ● | |
| 28Z ChairCot | | | | | | | | | | | | | | | | ● | |
| 93H Cot | | | | | | | | | | | | | | | | ● | |

| MODEL | FASTENERS (PAGES 46-47) | | | | | | | | | | | | | |
|--------------------------|-------------------------|--------------------|--------------------|--------------------|--------------------|----------|--------------------|--------------------|--------------|--------------|--------------|---------------|----------|-------------|
| | 175-1 Kit Complete | 175-2 Kit Complete | 175-3 Kit Complete | 175-4 Kit Complete | 175-5 Kit Complete | 5-14 | 173-2 Kit Complete | 173-3 Kit Complete | SLAM-26 | SLAM-26+ | SLAM-4050 | SLAM-5026/EFX | FL1 | StarTrac® |
| | PART # | | | | | | | | | | | | | |
| | #0001731F | #0001732F | #0001733F | #0001734F | #0001735F | #0573057 | #0001732F | #0001733F | Ferno Italia | Ferno Italia | Ferno Italia | Ferno Italia | #0573080 | See Page 47 |
| Mondial Transporter | | | | | | | | | | | | | | ● |
| Mondial RS Stretchers | | | | | | | | | | | | | | |
| Lift-Off Stretcher Chair | | | | | | | | | | | | | | |
| Mondial Monobloc | | | | | | | | | | | | | | ● |
| Model 17 York 2 Cot | | | | | | | | | | | | | | |
| Model 19 York 4 Cot | | | | | | | | | | | | | | |
| Model 25 Cot | ● | ● | ● | ● | ● | ● | | | | | | | | |
| Model 26 Series Cots | ● | ● | ● | ● | ● | | | | | ● | | | | |
| Model 28 Chair Cot | | | | | | | ● | ● | | | | | | |
| Model 35A Cot | ● | ● | ● | ● | ● | | | | | | | | | ● |
| Model 93ES Cot | ● | ● | ● | ● | ● | | | | | | | | | ● |
| Model 5126EL Cot | | | | | | | | | | | | | ● | |
| 4051/4052 Transporter | | | | | | | | | | ● | | | | |
| 4141/4142 Stretchers | | | | | | | | | | | | | | |
| 4153 Stretcher | | | | | | | | | | | | | | |
| POWERFlexx Cot | ● | ● | ● | ● | ● | | | | | | | | | ● |
| 26P Cot | | | | | | | | | | ● | | | | |
| 35X Cot | ● | ● | ● | ● | ● | | | | | | | | | ● |
| 28Z Chair Cot | | | | | | | ● | ● | | | | | | |
| 93H Cot | ● | ● | ● | ● | ● | | | | | | | | | ● |

| MODEL | ACCESSORIES (PAGES 40, 42, 56) | | | | | | | | | | | | | | | |
|--------------------------|--------------------------------|------------------------|--------------|----------------|----------|------------|--------------|-------------------|---------|-----------------|------------------|---------------------|------------|--------------------|-----------|--|
| | Head-End O2 Bracket | Oxygen Cylinder Holder | 514 Oxy-Clip | 514-1 Oxy-Clip | PacRac+ | 274 PacRac | 274-S PacRac | Equipment Bracket | Sof-Net | Sof-Net for 28Z | Metal Lower Tray | LBS Bariatric Board | LBS Junior | LBS Junior for 93H | | |
| | PART # | #08-21111 | #08-19958 | #0085500 | #0085520 | #FWEPR | #08-18933 | #08-18952 | #CA5250 | #08-21996 | #08-22178 | Order with Cot | #08-22057 | #08-22184 | #08-21936 | |
| Mondial Transporter | | | | | | | | | | | | | | | | |
| Mondial RS Stretchers | | ● | | | | | | | | | | | | | | |
| Lift-Off Stretcher Chair | | ● | | | | | | | | | | | | | | |
| Mondial Monobloc | | | ● | | | | | | | | | | | | | |
| Model 17 York 2 Cot | | ● | | | | | | ● | | | | | | | | |
| Model 19 York 4 Cot | | ● | | | | | | ● | | | | | | | | |
| Model 25 Cot | | ● | | | | | | ● | | | | | | | | |
| Model 26 Series Cots | | ● | | | | | | ● | | | | | | | | |
| Model 28 Chair Cot | | | ● | | | ● | | | | | | | | | | |
| Model 35A Cot | | ● | | | ● | | ● | | | ● | | | | | | |
| Model 93ES Cot | | ● | | | ● | | ● | | | ● | | | | | | |
| Model 5126EL Cot | | | | | | | | ● | | | | | | | | |
| 4051/4052 Transporter | | | | | | | | | | | | | | | | |
| 4141/4142 Stretchers | | ● | | | | | | ● | | | | | | | | |
| 4153 Stretcher | | ● | | | | | | | | | | | | | | |
| POWERFlexx Cot | ● | | | | ● | | ● | ● | | | ● | ● | | | | |
| 26P Cot | | | | | | | | ● | | | | | | | | |
| 35X Cot | ● | ● | | | ● | | ● | ● | | ● | ● | ● | | | | |
| 28Z Chair Cot | | | | | | ● | | | ● | ● | | | | | | |
| 93H Cot | | | | | ● | | ● | ● | | ● | ● | | | | ● | |

A

Ampoule Card 84
 Arachnidpod 108

B

Backboards
 AquaBoard 59
 Millennia Boards 58
 Model 60 Aluminum Backboards 64
 Model 889P Fiberglass Backboard 59
 NAJO Lite Board 61
 NAJO RediHold 60
 NAJO RediWide 60
 NAJO Sports Board 61

Bags

Emergency Respiratory Care Backpack 82
 Model 5100 Airway Management/Oxygen Bag 83
 Model 5103 Trauma Responder II Bag 80
 Model 5107 Professional Trauma Bag 80
 Model 5108 Professional ALS Bag 80
 Model 5110 Trauma Airway Management Bag II 82
 Model 5111 Trauma/Airway Management Bag III 82
 Model 5113 First-In Trauma Bag 81
 Model 5114 Medication Mini-Bag 84
 Model 5115 Intubation Mini-Bag 84
 Model 5116 Intravenous Mini-Bag 84
 Model 5117 Trauma Mini-Bag 84
 Model 5120 Oxygen Carry Bag 83
 Model 5121 Oxygen Carry Bag 83
 Model 5122 Oxygen Carry Bag 83
 Model 5130 Intubation Ultra Mini-Bag 84
 Model 5148 Luno Bag 81
 Model 5149 Luno Bag 81
 Model 5150 Rucksack with Airway Roll 81

Bariatric Tow Package 57

Bariatric Push/Pull Handles 57

Basket Stretchers

Advantage Basket Stretcher 102
 Model 71 Basket Stretcher 98
 Model 71-M Non-Metallic Basket Stretcher 98
 Model 71-S Split Basket Stretcher 98
 Spartan Basket Stretcher 99
 Titan Stainless Steel Basket Stretcher 100
 Traverse Rescue Gazelle Series Carbon Steel Basket Stretcher 101

Blankets

Model 352 100% Acrylic-Blend Blanket 44
 Model 353 Quilted Nylon Blanket 44
 Model 354 Wool-Blend Blanket 44
 RESQ Pillow 44
 Thermal Mylar Blanket 44

Boxes

Compact First Aid Boxes 87
 Flambeau 1702 Medical Box 86
 Flambeau 1872 Medical Box 86
 Flambeau 2072 Medical Box 86
 Flambeau 2272 Trauma Box 86
 Pelican Equipment Cases 87
 Plano 747-M Trauma Box 86
 Saver First Aid Kits 86
 Bridle, Model 418-1 98

C

Centrepoint II Full Body Harness 109
 Centrepoint Sit Harness 109
 Cervical Collars

Model 449 WizLoc Cervical Collar 67
 Challenge Pro Series Harnesses 109
 Church Trucks
 Cemetery Church Truck 120
 Model 87 Church Truck 120
 Model 88 Church Truck 120

Cots

28Z PROFlex Chair Cot 28
 35X PROFlex 26
 93H PROFlex Cot 29
 5126 Series Cots 19
 CCT Series 33
 F2 Monobloc 31
 Harrier LT 32
 Harrier LT-LBS 32, 54
 Model 19 Cot, York 4 10
 Model 25 Cot 11
 Model 26 Cot 12
 Model 26AS Cot 13
 Model 26P PROFlex Cot 24
 Model 26S Cots 13
 Model 28 Chair Cot 14
 Model 35-A Cot 16
 Model 35-A+ Mobile Cot 17
 Model 93-ES Squadmate Cot 18
 Mondial Monobloc 8
 POWERFlex Powered Cot 22, 54

CPR Board 75

CPR Mask 92

Critter RIT Tool 103

D

Defibrillator Mounts

D360 Swivel Defibrillator Mount 45
 M-200 Defibrillator Mount 45
 M-201 Defibrillator Mount 45
 P-300 Defibrillator Mount 45
 Z-102 Defibrillator Mount 45
 Z-103 Defibrillator Mount 45

Disaster Pouches

Model 347-1 Disposable Heavy-Duty Vinyl Disaster Pouch 118

Disposable Cuff Mask 91

DVRx Demand Valve Resuscitator 91

E

E-Class Flowmeter 90

Emergency Respiratory System 95

Equipment Bracket 42

EZ Glide Headrest 42

EZ Glide IV Pole 42

EZ Glide Mounts 42

EZ Glide Rear Lift Handles 42

F

Fasteners

FL-1 Fastener 47
 Model 5-14 Cot Fastener 47
 Model 173-2 Mounting Kit 47
 Model 173-3 Mounting Kit 47
 Model 175-1 Mounting Kit 46
 Model 175-2 Mounting Kit 46
 Model 175-3 Mounting Kit 46
 Model 175-4 Mounting Kit 46
 Model 175-5 Mounting Kit 46
 Model 185 StatTrac 46
 Slam Series Fasteners 47
 FDU 107

Flow Control Valves 90

G

Grip-ET Endotracheal Tube Holder 97

H

Head-End O2 Bracket 40

Head Immobilizers

Head Immobilizer 365-E 66
 Model 445 Universal Head Immobilizer 66
 Model 455 HeadHugger Head Immobilizer 67
 HFOC Oxygen Conserver 91

I

Incubator Transporters

ITC Incubator Transporter Interface 79
 ITU Incubator Transporter Unit 79
 Model 28-IT Incubator Transporter 78
 Model 35-IT Incubator Transporter 78
 Model 93-IT Incubator Transporter 78
 POWERFlex-IT Incubator Transporter 79

Individual Laryngoscope Blades 96

IndustriPOD 108

Intubation Kit Model 425 96

IV Poles

Model 513-10 Series Heavy-Duty IV Poles 41
 Model 2030 IV 41
 Mondial Monobloc IV Pole 41
 Mondial RS Mount IV Pole 41

K

KED, Model 125 68

KED PRO 68

KED SLED 68

Kigali Backpacks 110

L

Large Rescue Belay 106

Latex-Free Nasopharyngeal Airways 119

LBS Bariatric Board 56

Lead Handle (28Z) 42

M

Manta Transfer Sheet 53, 57

Medical Data Carrier 110

Micro-Manager Administrator 90

Mini Haul Kit 107

Mini-Manager Administrator 90

Mortuary Cots

Model 24-H Mortuary Cot 116
 Model 24-MiniMAXX Mortuary Cot 116
 Model 23 Mortuary Cot 117
 Model 24 Mortuary Cot 116
 Model 27-1 Mortuary Cot 116

Mortuary Fridges 121

Mule Litter Wheel 103

Multi-Manager Administrator 90

MVP Suction Unit 97

N

Nasopharyngeal Airways 96

O

OG1 Prusik Minding Pulley 106

Operating Tables

Model 101-H Hydraulic Table 119

Model 102 Folding Operating Table.....119
 Model 103 Combination Operating Table.....119
 OX-Series Inhalator Valve.....91
 Oxy-Clip2.....40
 Oxy-Clip Cylinder Holder40
 Oxygen Bottles93
 Oxygen Cylinder Holder.....40
 Oxygen Cylinders, Aluminum93
 Oxygen Hoses.....92
 Oxygen Mounts
 Model 515 and 516 Cylinder Brackets.....94
 Model 519 and 520 Bottle Base94
 Oxygen Bottle Holder94
 Oxygen Regulators
 BRAVO2 Brass Oxygen Regulators89
 ORO2 Oxygen Regulators88

P

PacRac42
 PacRac+.....42
 Patient Lifting Sling109
 Pediatrics
 Baby Pod II76
 Ferno Model 78 Pedi-Pac.....77
 Model 676 MEDkids Baby Board.....77
 Model 677 MEDkids Pedi-Sleeve77
 Model 678 Pedi-Mate.....76
 PEZO2 Pulse Oximeter.....97
 PosiTube Endotracheal Detection Device97

R

RDC Boat.....111
 Rescue Stretchers
 Lifesaver Rescue Stretcher105
 Paraguard Excel Rescue Stretcher105
 Res-Q-Mate Litter105
 Titan Stainless Steel Rescue Stretchers100
 Traverse Bradco Stretcher System.....102
 Traverse Rescue Stretcher104
 Vertical Rescue Stretcher.....104
 Res-Q-Link Recovery Pole.....107
 Restraints
 Model 414-OL (Over-The-Lap) Wrist Restraint....43
 Model 414-R Wrist Restraints, Cot Sidearm43
 Model 415 Ankle Restraint.....43
 Model 417-1 Harness Restraint43
 Model 430 Cot Restraints43
 Model 430-P Restraint Straps.....65
 Model 436 Swivel Speed-Clip Restraints65
 Model 770 Fastrap64
 Restraint Extenders.....57
 Universal Psychiatric Restraint Set43

S

SAR BackPack Portable Kit.....95
 Saver
 Frac Immobilizers115
 Head Immobilizer.....115
 Model S-219 Cot.....112
 Model S-240 Patient Transport Chair112
 Model S-242 Patient Transport Chair112
 Model S-242T Patient Transport Chair113
 Model S-2032 Stacking Catastrophe Stretcher 114
 Model S-2108A and S-2108AF.....114
 Safe Evacuation Chair113
 Vacuum Splints115
 Saver Bags
 Model 2100 First Responder Bag.....85

Model 2102 Trauma Responder Bag II.....85
 Model 2103 Trauma Responder Bag III.....85
 Model 2110 O2 Trauma Kit85
 Model 2120 O2 Duffel Kit85
 Model 2130 ALS Bag85
 Scoop Stretchers
 Model 65 Scoop Stretcher.....64
 Mortuary Scoop EXL117
 Scoop EXL Stretcher62
 Sea Scoopa111
 Seahorse Portable Airway Kit.....95
 Side Extension Panels118
 Silicone Face Masks91
 Silicone Resuscitators92
 Single Patient Use BVM92
 Sof-Net Head End Storage42
 SPED69
 Splints
 Air Splint Kit Model 66370
 Ferno Frac-Care Kit71
 Finger-Splint Kit75
 Germa EasyFix Vacuum Splints74
 Model AS190 Vacuum Splint Extremity Kit74
 Model 441, 443, 444 Ferno Trac Traction Splints 70
 Padded Board Splint74
 Prosplints.....71
 SAM Pelvic Sling II75
 SAM Splint75
 Spreader Bar.....107
 Stair Chairs
 Compact 2 Carry Chair37
 Compact 2 Track Chair.....37
 EZ Glide LBS55
 EZ Glide PowerTraxx Stair Chair35
 Model 40 Stair Chair36
 Model 42 Stair Chair36
 Model 48 Stair Chair36
 Model 59T EZ Glide Stair Chair34
 Utilia Chair Model ALS 10338
 Utilia Chair Model ALS 30038
 Utilia Chair Model ALS 400 S39
 Utilia Chair Model LTS 70039
 Stretchers
 Combination Stretcher/Body Bag.....52
 Emergency Stretchers
 Model 9 Emergency Stretcher49
 Model 11 Emergency Stretcher48
 Model 11-T Track Emergency Stretcher ..48, 117
 Model 12 Emergency Stretcher49
 Model 12-C Emergency Breakaway Stretcher 49
 Lift-Off Stretchers
 F2 Stretcher30
 Lift-Off Stretcher Chair7
 Model 4141/4142 Lift-Off Stretcher21
 Model 4153 Lift-Off Stretcher Chair21
 Mondial RS2 Lift-Off Stretcher.....6
 Mondial RS3 Lift-Off Stretcher.....6
 Mondial RS4 Lift-Off Stretcher.....7
 Pole Stretchers
 Model 108 Single-Fold Pole Stretcher51
 Model 108-A Single-Fold Pole Stretcher.....51
 Model 108-AF Double-Fold Pole Stretcher51
 Model 108-D Disaster Litter.....52
 Model 108-F Single Fold-Pole Stretcher51
 Model 108-T Tactical Litter52
 Stretcher Chairs
 Model 107 Stretcher Chair50
 Model 107-C.....50
 Swing-Out Lift Handles (28Z).....42

T

Tablu Tri-Fold Board.....103
 Transporters
 F2 Transporter30
 Model 4051 Transporter20
 Model 4052 Transporter20
 Mondial Transporter.....4
 Traverse Litter Bridle.....106

U

Ultralite X Harness.....109

V

Vacuum Mattresses
 Germa EasyFix Vacuum Mattress.....72
 Germa Transfer Mattresses73
 Model 192 Full-Body Vacuum Mattress.....72
 Safe Transfer Mattress.....73
 Vertical Rescue Triangular Harness109
 Vial Card84

W

Wall Mounted Blood Pressure Cuff97

X

XT69

| | | | | | |
|------------------------------------|--------|---------------------------------------|-----|--------------------------------------|--------|
| 5-14 Cot Fastener..... | 47 | 356 Fire Blanket..... | 44 | 5103 Bag..... | 80 |
| 9 Stretcher..... | 49 | 365-E Head Immobilizer..... | 66 | 5107 Bag..... | 80 |
| 11 Stretcher..... | 48 | 414-OL Restraints..... | 43 | 5108 Bag..... | 80 |
| 11-T Stretcher..... | 48 | 414-R Restraints..... | 43 | 5110 Bag..... | 82 |
| 12-C Stretcher..... | 49 | 415 Ankle Restraint..... | 43 | 5111 Bag..... | 82 |
| 12 Stretcher..... | 49 | 417-1 Harness Restraint..... | 43 | 5113 Bag..... | 81 |
| 19 Cot..... | 10 | 418-1 Harness Restraint..... | 98 | 5114 Bag..... | 84 |
| 23 Mortuary Cot..... | 116 | 425 Intubation Kit..... | 96 | 5115 Bag..... | 84 |
| 24-H Mortuary Cot..... | 116 | 430-P Restraints..... | 65 | 5116 Bag..... | 84 |
| 24-miniMAXX Mortuary Cot..... | 116 | 430 Restraints..... | 43 | 5117 Bag..... | 84 |
| 24 Mortuary Cot..... | 116 | 436 Restraints..... | 65 | 5118 Vial Card..... | 84 |
| 25 Cot..... | 11 | 439 Restraints..... | 65 | 5120 Bag..... | 83 |
| 26AS Cot..... | 13 | 441 Traction Splints..... | 70 | 5121 Bag..... | 83 |
| 26 Cot..... | 12 | 443 Traction Splints..... | 70 | 5122 Bag..... | 83 |
| 26-P Cot..... | 24 | 444 Traction Splints..... | 70 | 5126 Cot..... | 19 |
| 26S Cot..... | 13 | 445 Head Immobilizer..... | 66 | 5126EL Cot..... | 19 |
| 27-1 First-Call Cot..... | 116 | 449 WizLoc..... | 67 | 5130 Bag..... | 84 |
| 28 Chair Cot..... | 14 | 513-10 IV Poles..... | 41 | 5148 Bag..... | 81 |
| 28-IT Incubator Transporter..... | 79 | 514 Oxy-Clip..... | 40 | 5149 Bag..... | 81 |
| 28Z Chair Cot..... | 28 | 515 Cylinder Bracket..... | 94 | 5150 Rucksack..... | 81 |
| 35A Cot..... | 16 | 516 Cylinder Bracket..... | 94 | Advantage..... | 101 |
| 35A+ Cot..... | 17 | 519 Bottle Case..... | 94 | ALS 103 Chair..... | 38 |
| 35-IT Incubator Transporter..... | 78 | 520 Bottle Case..... | 94 | ALS 300 Chair..... | 38 |
| 35X Cot..... | 26 | 521 Oxygen Bottle Holder..... | 94 | ALS 400-S Chair..... | 39 |
| 40 Stair Chair..... | 36 | 540' Large Rescue Belay..... | 106 | Aluminum Oxygen Cylinders..... | 93 |
| 42 Stair Chair..... | 36 | 663 Air Splint Kit..... | 70 | AS190 Vacuum Splints..... | 74 |
| 48 Stair Chair..... | 36 | 672 CPR Board..... | 75 | Arachnipod..... | 108 |
| 59T EZ Glide..... | 34 | 676 Baby Board..... | 77 | Baby Pod II..... | 76 |
| 60 Aluminum Backboards..... | 64 | 677 Pedi-Sleeve..... | 77 | Bariatric Push/Pull Handles..... | 57 |
| 65EXL Scoop..... | 62 | 678 Pedi-Mate..... | 76 | Bariatric Tow Package..... | 57 |
| 65 Scoop..... | 64 | 680 Fire Blanket with Case..... | 44 | Berman Airways..... | 96 |
| 71 Basket Stretcher..... | 98 | 747-M Box..... | 86 | Bradco..... | 102 |
| 71-M Basket Stretcher..... | 98 | 770 Fastrap..... | 64 | BVM..... | 92 |
| 71-S Basket Stretcher..... | 98 | 773 Swivel Speed Clip Restraints..... | 65 | CCT Series..... | 33 |
| 75 Polar Boat..... | 111 | 804 Oxygen Regulator..... | 88 | Centrepoint 2..... | 108 |
| 78 Pedi-Pac..... | 77 | 816 Oxygen Regulator..... | 88 | Challenge Pro Series Harnesses..... | 109 |
| 87 Church Truck..... | 120 | 817 Oxygen Regulator..... | 88 | Compact 2..... | 37 |
| 88 Church Truck..... | 120 | 818d Oxygen Regulator..... | 88 | Compact 2 Track..... | 37 |
| 93-ES Cot..... | 18 | 818 Oxygen Regulator..... | 88 | Compact First Aid Boxes..... | 87 |
| 93H Cot..... | 29 | 819 Oxygen Regulator..... | 88 | CPR Mask..... | 97 |
| 93-IT Incubator Transporter..... | 78 | 830 Oxygen Regulator..... | 89 | Critter RIT Tool..... | 45 |
| 101-H Table..... | 119 | 831 Oxygen Regulator..... | 89 | D360 Swivel Defibrillator Mount..... | 45 |
| 102 Table..... | 119 | 832 Oxygen Regulator..... | 89 | Disposable Cuff Mask..... | 91 |
| 103 Table..... | 119 | 833 Oxygen Regulator..... | 89 | DVRx Demand Valve Resuscitator..... | 91 |
| 107-C Stretcher..... | 50 | 889-P Fiberglass Backboard..... | 59 | E-Class Flowmeter..... | 90 |
| 107 Stretcher..... | 50 | 903 Micro-Manager..... | 90 | Emergency Respiratory System..... | 95 |
| 108-AF Stretcher..... | 51 | 905 Mini-Manager..... | 90 | ERC..... | 82 |
| 108-A Stretcher..... | 51 | 908 Multi-Manager..... | 90 | EZ Glide Headrest..... | 42 |
| 108-D Litter..... | 52 | 1702 Box..... | 86 | EZ Glide IV Pole..... | 42 |
| 108-F Stretcher..... | 51 | 1872 Box..... | 86 | EZ Glide LBS..... | 55 |
| 108 Stretcher..... | 51 | 2030 IV Pole..... | 35 | EZ Glide Mounts..... | 42 |
| 108-T Litter..... | 52 | 2072 Box..... | 86 | EZ Glide PowerTraxx Stair Chair..... | 35 |
| 132 Manta..... | 53, 57 | 2100 Bag..... | 85 | F2 Transporter & Stretcher..... | 30 |
| 135 Stretcher/Body Bag..... | 52 | 2102 Bag..... | 85 | F2 Monobloc..... | 31 |
| 173 Cot Fasteners..... | 47 | 2103 Bag..... | 85 | FDU..... | 107 |
| 175 Cot Fasteners..... | 46 | 2108AF Stretcher..... | 114 | Finger-Splint..... | 75 |
| 192 Vacuum Mattress..... | 72 | 2108A Stretcher..... | 114 | FL1 Fastener..... | 47 |
| 205 Bottle..... | 93 | 2110 Bag..... | 85 | Flow Control Valves..... | 108 |
| 206 Bottle..... | 93 | 2120 Bag..... | 85 | Frac-Care..... | 71 |
| 210 Bottle..... | 93 | 2130 Bag..... | 85 | Gazelle..... | 101 |
| 211 Bottle..... | 93 | 2020 Equipment Bracket..... | 42 | Germa EasyFix Vacuum Mattress..... | 72 |
| 274 PacRac..... | 42 | 2272 Box..... | 86 | Germa EasyFix Vacuum Splints..... | 74 |
| 301 HFOC..... | 91 | 4051 Transporter..... | 20 | Germa Transfer Mattress..... | 73 |
| 302 OX-Series Inhalator Valve..... | 91 | 4052 Transporter..... | 20 | Grip-ET..... | 119 |
| 347-1 Disaster Pouch..... | 118 | 4141 Stretcher..... | 21 | Hard Metal Lower Tray..... | 36 |
| 352 Acrylic Blanket..... | 44 | 4142 Stretcher..... | 21 | Hardpoint Full Body Harness..... | 108 |
| 353 Quilted Nylon Blanket..... | 44 | 4153 Stretcher Chair..... | 21 | Harrier LT..... | 32 |
| 354 Wool-Blend Blanket..... | 44 | 5100 Bag..... | 83 | Harrier LT-LBS..... | 32, 54 |

| | | | |
|--|--------|--|-----|
| Head-End O2 Bracket..... | 40 | Tablu Tri-fold Board..... | 103 |
| Individual Laryngoscope Blades..... | 96 | Ultralite X Harness..... | 74 |
| ISO Chamber | 53 | Vacuum Mattress | 72 |
| IndustriPOD | 108 | Vacuum Splints..... | 74 |
| ITC Incubator Transporter Interface..... | 79 | Vertical Rescue Stretcher | 104 |
| ITU Incubator Transporter Unit..... | 79 | Vertical Rescue Triangular Harness | 109 |
| KED PRO..... | 68 | Wall Mounted Blood Pressure Cuff | 97 |
| KED SLED | 68 | XT | 69 |
| Kigali 30 Backpack..... | 110 | Z-102 Defibrillator Mount..... | 45 |
| Kigali 35 Backpack..... | 110 | Z-103 Defibrillator Mount..... | 45 |
| Kigali 45 Backpack..... | 110 | | |
| Latex-Free Nasopharyngeal Airways..... | 119 | | |
| LBS | 56 | | |
| Lifesaver Rescue Stretcher | 105 | | |
| LTS 700..... | 39 | | |
| M-200 Defibrillator Mount | 45 | | |
| M-201 Defibrillator Mount | 45 | | |
| Millennia | 58 | | |
| Mini Haul Kit | 107 | | |
| Mondial RS2 Stretcher | 6 | | |
| Mondial RS3 Stretcher | 6 | | |
| Mondial RS4 Stretcher | 7 | | |
| Mondial Transporter..... | 8 | | |
| Mortuary Fridges..... | 121 | | |
| Mule Litter Wheel | 102 | | |
| MVP | 97 | | |
| NAJO | 60-61 | | |
| Oxy-Clip | 40 | | |
| Oxy-Clip2..... | 40 | | |
| Oxygen Cylinder Holder..... | 40 | | |
| Oxygen Hoses..... | 92 | | |
| P-300 Defibrillator Mount..... | 45 | | |
| Padded Board Splint..... | 74 | | |
| Paraguard | 105 | | |
| Patient Lifting Sling | 109 | | |
| PEZO2 Pulse Oximeter..... | 97 | | |
| Pelican | 87 | | |
| PosiTube | 97 | | |
| POWERFlexx | 22, 54 | | |
| ProSplints..... | 71 | | |
| Res-Q-Mate Litter | 105 | | |
| Res-Q-Link..... | 107 | | |
| RESQ Pillow..... | 44 | | |
| S-219 Cot | 112 | | |
| S-240 Patient Transport Chair | 112 | | |
| S-242 Patient Transport Chair | 112 | | |
| S-242T Patient Transport Chair | 113 | | |
| S-2032 Stretcher..... | 114 | | |
| SAM Splints..... | 75 | | |
| SAR BackPacks | 95 | | |
| Saver Frac Immobilizers | 115 | | |
| Saver Head Immobilizer..... | 115 | | |
| Saver Safe Evacuation Chair | 113 | | |
| Saver Vacuum Splints..... | 115 | | |
| Sea Scoopa | 111 | | |
| Seahorse Portable Airway Kit..... | 95 | | |
| Side Extension Panels | 118 | | |
| Silicone Resuscitators | 111 | | |
| Slam Series Fasteners..... | 47 | | |
| Sof-Net | 42 | | |
| SPED | 69 | | |
| Spartan..... | 99 | | |
| Spreader Bar..... | 107 | | |
| Thermal Mylar Blanket..... | 44 | | |
| Titan | 100 | | |
| Transfer Mattresses | 73 | | |
| Traverse RDC | 111 | | |
| Traverse Rescue Stretcher | 104 | | |



Equipos de Seguridad Industrial e Institucional, S.A. de C.V.

**ACCESO NORTE 280 INT. 3 SAN LUIS POTOSI, S.L.P. C.P.
78038**

TEL. (444) 5359760 y 8-31-45-09

**Correo Electrónico: ventas@esiisaslp.com
ventasesiisaslp2@Gmail.com**

